



Cisco Model DPC3928/EPC3928
DOCSIS/EuroDOCSIS 3.0 8x4
Wireless Residential Gateway with
Embedded Digital Voice Adapter
User Guide

Please Read

Important

Read this entire guide. If this guide provides installation or operation instructions, give particular attention to all safety statements included in this guide.

Notices

Trademark Acknowledgments

Cisco and the Cisco logo are trademarks or registered trademarks of Cisco and/or its affiliates in the U.S. and other countries. To view a list of Cisco trademarks, go to this URL: www.cisco.com/go/trademarks. DOCSIS is a registered trademark of Cable Television Laboratories, Inc. EuroDOCSIS, EuroPacketCable, and PacketCable are trademarks of Cable Television Laboratories, Inc. The Wi-Fi Protected Setup mark is a mark of the Wi-Fi Alliance. Wi-Fi Protected Setup is a trademark of the Wi-Fi Alliance.

Other third party trademarks mentioned are the property of their respective owners.

The use of the word partner does not imply a partnership relationship between Cisco and any other company. (1110R)

Publication Disclaimer

Cisco Systems, Inc. assumes no responsibility for errors or omissions that may appear in this publication. We reserve the right to change this publication at any time without notice. This document is not to be construed as conferring by implication, estoppel, or otherwise any license or right under any copyright or patent, whether or not the use of any information in this document employs an invention claimed in any existing or later issued patent.

Disclaimer

The maximum performance for wireless is derived from IEEE Standard 802.11 specifications. Actual performance can vary, including lower wireless network capacity, data throughput rate, range and coverage. Performance depends on many factors, conditions and variables, including distance from the access point, volume of network traffic, building materials and construction, operating system used, mix of wireless products used, interference and other adverse conditions.

Software and Firmware Use

The software described in this document is protected by copyright law and furnished to you under a license agreement. You may only use or copy this software in accordance with the terms of your license agreement.

The firmware in this equipment is protected by copyright law. You may only use the firmware in the equipment in which it is provided. Any reproduction or distribution of this firmware, or any portion of it, without our express written consent is prohibited.

Copyright

© 2014 Cisco Systems, Inc. All rights reserved.

Information in this publication is subject to change without notice. No part of this publication may be reproduced or transmitted in any form, by photocopy, microfilm, xerography, or any other means, or incorporated into any information retrieval system, electronic or mechanical, for any purpose, without the express permission of Cisco Systems, Inc.

Contents

IMPORTANT SAFETY INSTRUCTIONS	vii
United States FCC Compliance	xi
CE Compliance	xiii
EU Compliance	xvi
About This Guide	xvii
Introducing the DOCSIS Wireless Residential Voice Gateway	1
Introduction	2
What's In the Carton?	3
Front Panel Description	4
Back Panel Description	6
Installing the DOCSIS Wireless Residential Voice Gateway	9
Installation Preparations	10
Install the Wireless Residential Voice Gateway	18
Operation of Front Panel Indicators	21
Initial Power On, Calibration, and Registration (AC Power applied)	22
Normal Operations (AC Power Applied)	24
Special Conditions	26
Maintaining the Battery	27
Location of the Battery	28
Battery Maintenance	29



Troubleshooting the DOCSIS Wireless Residential Voice Gateway 31

Frequently Asked Questions	32
Common Troubleshooting Issues	37
Tips for Improved Performance	39

Customer Information 41



Notice to Installers

The servicing instructions in this notice are for use by qualified service personnel only. To reduce the risk of electric shock, do not perform any servicing other than that contained in the operating instructions, unless you are qualified to do so.

<p>Note to System Installer</p> <p>For this apparatus, the coaxial cable shield/ screen shall be grounded as close as practical to the point of entry of the cable into the building. For products sold in the US and Canada, this reminder is provided to call the system installer's attention to Article 820-93 and Article 820-100 of the NEC (or Canadian Electrical Code Part 1), which provides guidelines for proper grounding of the coaxial cable shield.</p>	 <p>CAUTION: To reduce the risk of electric shock, do not remove cover (or back). No user-serviceable parts inside. Refer servicing to qualified service personnel.</p> <p>WARNING TO PREVENT FIRE OR ELECTRIC SHOCK, DO NOT EXPOSE THIS UNIT TO RAIN OR MOISTURE.</p>
 <p>This symbol is intended to alert you that uninsulated voltage within this product may have sufficient magnitude to cause electric shock. Therefore, it is dangerous to make any kind of contact with any inside part of this product.</p>	 <p>This symbol is intended to alert you of the presence of important operating and maintenance (servicing) instructions in the literature accompanying this product.</p>



Notice à l'attention des installateurs de réseaux câblés

Les instructions relatives aux interventions d'entretien, fournies dans la présente notice, s'adressent exclusivement au personnel technique qualifié. Pour réduire les risques de chocs électriques, n'effectuer aucune intervention autre que celles décrites dans le mode d'emploi et les instructions relatives au fonctionnement, à moins que vous ne soyez qualifié pour ce faire.

<p>Remarque à l'attention de l'installateur du système</p> <p>Avec cet appareil, le blindage/écran du câble coaxial doit être mis à la terre aussi près que possible du point d'entrée du câble dans le bâtiment. En ce qui concerne les produits vendus aux États-Unis et au Canada, ce rappel est fourni pour attirer l'attention de l'installateur sur les articles 820-93 et 820-100 du Code national de l'électricité (ou Code de l'électricité canadien, Partie 1) qui fournissent des lignes directrices concernant la mise à la terre correcte du blindage (écran) du câble coaxial.</p>	 <p>ATTENTION: Pour réduire les risques de chocs électriques, ne pas enlever le couvercle (ou le panneau arrière). Ne contient aucune pièce réparable par l'utilisateur. Confier les interventions aux techniciens d'entretien qualifiés.</p> <p>AVERTISSEMENT POUR ÉVITER LES INCENDIES OU LES CHOCS ÉLECTRIQUES, NE PAS EXPOSER L'APPAREIL À LA PLUIE OU À L'HUMIDITÉ.</p>
 <p>Ce symbole a pour but de vous prévenir que des tensions électriques non isolées existent à l'intérieur de ce produit, pouvant être d'une intensité suffisante pour causer des chocs électriques. Il est donc dangereux d'établir un contact quelconque avec l'une des pièces comprises à l'intérieur de ce produit.</p>	 <p>Ce symbole a pour but de vous prévenir de la présence d'instructions importantes relatives au fonctionnement ou à l'entretien (et aux réparations) dans la documentation accompagnant ce produit.</p>

Mitteilung für CATV-Techniker

Die in dieser Mitteilung aufgeführten Wartungsanweisungen sind ausschließlich für qualifiziertes Fachpersonal bestimmt. Um die Gefahr eines elektrischen Schlags zu reduzieren, sollten Sie keine Wartungsarbeiten durchführen, die nicht ausdrücklich in der Bedienungsanleitung aufgeführt sind, außer Sie sind zur Durchführung solcher Arbeiten qualifiziert.

<p>Mitteilung an den Systemtechniker</p> <p>Für dieses Gerät muss der Koaxialkabelschutz/ Schirm so nahe wie möglich am Eintrittspunkt des Kabels in das Gebäude geerdet werden. Dieser Erinnerungshinweis liegt den in den USA oder Kanada verkauften Produkten bei. Er soll den Systemtechniker auf Paragraph 820-93 und Paragraph 820-100 der US-Elektrovorschrift NEC (oder der kanadischen Elektrovorschrift Canadian Electrical Code Teil 1) aufmerksam machen, in denen die Richtlinien für die ordnungsgemäße Erdung des Koaxialkabelschirms festgehalten sind.</p>	 <p>CAUTION RISK OF ELECTRIC SHOCK DO NOT OPEN</p> <p>ACHTUNG STROMSCHLAGEGFAHR, NICHT ÖFFNEN</p>
 <p>Dieses Symbol weist den Benutzer auf das Vorhandensein von nicht isolierten gefährlichen Spannungen im Gerät hin, die Stromschläge verursachen können. Ein Kontakt mit den internen Teilen dieses Produktes ist mit Gefahren verbunden.</p>	<p>ACHTUNG: Zur Vermeidung eines Stromschlags darf die Abdeckung (bzw. die Geräterückwand) nicht entfernt werden. Das Gerät enthält keine vom Benutzer wartbaren Teile. Wartungsarbeiten dürfen nur von qualifiziertem Fachpersonal durchgeführt werden.</p> <p>WARNUNG DAS GERÄT NICHT REGEN ODER FEUCHTIGKEIT AUSSETZEN, UM STROMSCHLAG ODER DURCH EINEN KURZSCHLUSS VERURSACHTEN BRAND ZU VERMEIDEN.</p>  <p>Dieses Symbol weist den Benutzer darauf hin, dass die mit diesem Produkt gelieferte Dokumentation wichtige Betriebs- und Wartungsanweisungen für das Gerät enthält.</p>

Aviso a los instaladores de sistemas CATV

Las instrucciones de reparación contenidas en el presente aviso son para uso exclusivo por parte de personal de mantenimiento cualificado. Con el fin de reducir el riesgo de descarga eléctrica, no realice ninguna otra operación de reparación distinta a las contenidas en las instrucciones de funcionamiento, a menos que posea la cualificación necesaria para hacerlo.

<p>Nota para el instalador del sistema</p> <p>En lo que se refiere a este aparato, el blindaje del cable coaxial debe conectarse a tierra lo más cerca posible al punto por el cual el cable entra en el edificio. En el caso de los productos vendidos en los EE. UU. y Canadá, el presente aviso se suministra para llamar la atención del instalador del sistema sobre los Artículos 820-93 y 820-100 del NEC (o Código Eléctrico de Canadá, Parte 1), que proporcionan directrices para una correcta conexión a tierra del blindaje del cable coaxial.</p>	 <p>CAUTION RISK OF ELECTRIC SHOCK DO NOT OPEN</p> <p>ATENCIÓN RIESGO DE DESCARGA ELÉCTRICA NO ABRIR</p>
 <p>Este símbolo tiene como fin advertirle de que una tensión sin aislamiento en el interior de este producto podría ser de una magnitud suficiente como para provocar una descarga eléctrica. Por consiguiente, resulta peligroso realizar cualquier tipo de contacto con alguno de los componentes internos de este producto.</p>	<p>ATENCIÓN: con el fin de reducir el riesgo de descarga eléctrica, no retire la tapa (ni la parte posterior). No existen en el interior componentes que puedan ser reparados por el usuario. Encargue su revisión a personal de mantenimiento cualificado.</p> <p>ADVERTENCIA PARA EVITAR EL RIESGO DE INCENDIO O DESCARGA ELÉCTRICA, NO EXPONGA LA UNIDAD A LA LLUVIA O A LA HUMEDAD.</p>  <p>Este símbolo tiene como fin alertarle de la presencia de importantes instrucciones de operación y mantenimiento (revisión) contenidas en la literatura que acompaña al producto.</p>

IMPORTANT SAFETY INSTRUCTIONS

- 1) Read these instructions.
- 2) Keep these instructions.
- 3) Heed all warnings.
- 4) Follow all instructions.
- 5) Do not use this apparatus near water.
- 6) Clean only with dry cloth.
- 7) Do not block any ventilation openings. Install in accordance with the manufacturer's instructions.
- 8) Do not install near any heat sources such as radiators, heat registers, stoves, or other apparatus (including amplifiers) that produce heat.
- 9) Do not defeat the safety purpose of the polarized or grounding-type plug. A polarized plug has two blades with one wider than the other. A grounding-type plug has two blades and a third grounding prong. The wide blade or the third prong is provided for your safety. If the provided plug does not fit into your outlet, consult an electrician for replacement of the obsolete outlet.
- 10) Protect the power cord from being walked on or pinched particularly at plugs, convenience receptacles, and the point where they exit from the apparatus.
- 11) Only use attachments/accessories specified by the manufacturer.
- 12)  Use only with the cart, stand, tripod, bracket, or table specified by the manufacturer, or sold with the apparatus. When a cart is used, use caution when moving the cart/apparatus combination to avoid injury from tip-over.
- 13) Unplug this apparatus during lightning storms or when unused for long periods of time.
- 14) Refer all servicing to qualified service personnel. Servicing is required when the apparatus has been damaged in any way, such as a power-supply cord or plug is damaged, liquid has been spilled or objects have fallen into the apparatus, the apparatus has been exposed to rain or moisture, does not operate normally, or has been dropped.

Power Source Warning

A label on this product indicates the correct power source for this product. Operate this product only from an electrical outlet with the voltage and frequency indicated on the product label. If you are uncertain of the type of power supply to your home or business, consult your service provider or your local power company.

The AC inlet on the unit must remain accessible and operable at all times.

Ground the Product



WARNING: Avoid electric shock and fire hazard! If this product connects to coaxial cable wiring, be sure the cable system is grounded (earthed). Grounding provides some protection against voltage surges and built-up static charges.

Protect the Product from Lightning

In addition to disconnecting the AC power from the wall outlet, disconnect the signal inputs.

Verify the Power Source from the On/Off Power Light

When the on/off power light is not illuminated, the apparatus may still be connected to the power source. The light may go out when the apparatus is turned off, regardless of whether it is still plugged into an AC power source.

Eliminate AC Power/Mains Overloads



WARNING: Avoid electric shock and fire hazard! Do not overload AC power/mains, outlets, extension cords, or integral convenience receptacles. For products that require battery power or other power sources to operate them, refer to the operating instructions for those products.

Handling Disposable Batteries

This product may contain a rechargeable Lithium-Ion battery to provide stand-by operation in the event of an AC power failure.

Heed the following warning, follow the Battery Safety and Battery Disposal instructions below, and see the instructions later in this guide for handling, replacing, and disposing of the battery.



WARNING: There is danger of explosion if the battery is mishandled or incorrectly replaced. Replace only with the battery recommended by the manufacturer. Do not disassemble it or attempt to recharge it outside the system. Do not crush, puncture, dispose of in fire, short the external contacts, or expose to water or other liquids. Dispose of the battery in accordance with local regulations and instructions from your service provider.

Battery Safety

- Insert batteries correctly. There may be a risk of explosion if the batteries are incorrectly inserted.
- Do not attempt to recharge 'disposable' or 'non-reusable' batteries.
- Please follow instructions provided for charging 'rechargeable' batteries.
- Replace batteries with the same or equivalent type that we recommend.
- Do not expose batteries to excessive heat (such as sunlight or fire).
- Do not expose batteries to temperatures above 100°C (212°F).

Battery Disposal

- The batteries may contain substances that could be harmful to the environment.
- Recycle or dispose of batteries in accordance with the battery manufacturer's instructions and local/national disposal and recycling regulations.



廢電池請回收

- The batteries may contain perchlorate, a known hazardous substance, so special handling and disposal of this product might be necessary. For more information about perchlorate and best

management practices for perchlorate-containing substance, see www.dtsc.ca.gov/hazardouswaste/perchlorate

Provide Ventilation and Select a Location

- Remove all packaging material before applying power to the product.
- Do not place this apparatus on a bed, sofa, rug, or similar surface.
- Do not place this apparatus on an unstable surface.
- Do not install this apparatus in an enclosure, such as a bookcase or rack, unless the installation provides proper ventilation.
- Do not place entertainment devices (such as VCRs or DVDs), lamps, books, vases with liquids, or other objects on top of this product.
- Do not block ventilation openings.

Operating Environment

This product is designed for operation indoors with a temperature range from 32° to 104° F (0° to 40°C). Each product should have adequate spacing on all sides so that the cooling air vents on the chassis are not blocked.

Protect from Exposure to Moisture and Foreign Objects



WARNING: Avoid electric shock and fire hazard! Do not expose this product to dripping or splashing liquids, rain, or moisture. Objects filled with liquids, such as vases, should not be placed on this apparatus.



WARNING: Avoid electric shock and fire hazard! Unplug this product before cleaning. Do not use a liquid cleaner or an aerosol cleaner. Do not use a magnetic/static cleaning device (dust remover) to clean this product.



WARNING: Avoid electric shock and fire hazard! Never push objects through the openings in this product. Foreign objects can cause electrical shorts that can result in electric shock or fire.

Service Warnings



WARNING: Avoid electric shock! Do not open the cover of this product. Opening or removing the cover may expose you to dangerous voltages. If you open the cover, your warranty will be void. This product contains no user-serviceable parts.

Check Product Safety

Upon completion of any service or repairs to this product, the service technician must perform safety checks to determine that this product is in proper operating condition.

Protect the Product When Moving It

Always disconnect the power source when moving the apparatus or connecting or disconnecting cables.

IMPORTANT SAFETY INSTRUCTIONS

Telephone Equipment Notice

When using your telephone equipment, basic safety precautions should always be followed to reduce the risk of fire, electric shock and injury to persons, including the following:

1. Do not use this product near water, for example, near a bath tub, wash bowl, kitchen sink or laundry tub, in a wet basement or near a swimming pool.
2. Avoid using a telephone (other than a cordless type) during an electrical storm. There may be a remote risk of electric shock from lightning.
3. Do not use the telephone to report a gas leak in the vicinity of the leak.



CAUTION: To reduce the risk of fire, use only No. 26 AWG or larger telecommunication line cord.

SAVE THESE INSTRUCTIONS

United States FCC Compliance

This device has been tested and found to comply with the limits for a Class B digital device, pursuant to part 15 of the FCC Rules. These limits are designed to provide reasonable protection against such interference in a residential installation. This equipment generates, uses, and can radiate radio frequency energy. If not installed and used in accordance with the instructions, it may cause harmful interference to radio communications. However, there is no guarantee that interference will not occur in a particular installation. If this equipment does cause harmful interference to radio or television reception, which can be determined by turning the equipment OFF and ON, the user is encouraged to try to correct the interference by one or more of the following measures:

- Reorient or relocate the receiving antenna.
- Increase the separation between the equipment and receiver.
- Connect the equipment into an outlet on a circuit different from that to which the receiver is connected.
- Consult the service provider or an experienced radio/television technician for help.

Any changes or modifications not expressly approved by Cisco Systems, Inc., could void the user's authority to operate the equipment.

The information shown in the FCC Declaration of Conformity paragraph below is a requirement of the FCC and is intended to supply you with information regarding the FCC approval of this device. *The phone numbers listed are for FCC-related questions only and not intended for questions regarding the connection or operation for this device. Please contact your service provider for any questions you may have regarding the operation or installation of this device.*

FC Declaration of Conformity

This device complies with Part 15 of FCC Rules. Operation is subject to the following two conditions: 1) the device may not cause harmful interference, and 2) the device must accept any interference received, including interference that may cause undesired operation.

<p>DOCSIS Wireless Residential Voice Gateway Model(s): DPC3928 EPC3928 Manufactured by: Cisco Systems, Inc. 170 West Tasman Drive San Jose, California 95134 USA</p>
--

Canada EMI Regulation

This Class B digital apparatus complies with Canadian ICES-003.

Cet appareil numérique de la class B est conforme à la norme NMB-003 du Canada.

RF Exposure Statements

Note: This transmitter must not be co-located or operated in conjunction with any other antenna or transmitter. This equipment should be installed and operated with a minimum distance of 7.9 inches (20 cm) between the radiator and your body. For products available in the USA/Canada market, only channels 1-11 can be operated. The selection of other channels is not possible.

US

This system has been evaluated for RF exposure for humans in reference to ANSI C 95.1 (American National Standards Institute) limits. The evaluation was based in accordance with FCC OET Bulletin 65C rev 01.01 in compliance with Part 2.1091 and Part 15.27. The minimum separation distance from the antenna to general bystander is 7.9 inches (20 cm) to maintain compliance.

Canada

This system has been evaluated for RF exposure for humans in reference to Canada Health Code 6 (2009) limits. The evaluation was based on evaluation per RSS-102 Rev 4. The minimum separation distance from the antenna to general bystander is 7.9 inches (20 cm) to maintain compliance.

CE Compliance

Declaration of Conformity with Regard to the EU Directive 1999/5/EC (R&TTE Directive)

This declaration is only valid for configurations (combinations of software, firmware and hardware) supported or provided by Cisco Systems for use within the EU. The use of software or firmware not supported or provided by Cisco Systems may result in the equipment no longer being compliant with the regulatory requirements.

Български [Bulgarian]:	Това оборудване отговаря на съществените изисквания и приложими клаузи на Директива 1999/5/EC.
Cesky [Czech]:	Toto zařízení je v souladu se základními požadavky a ostatními odpovídajícími ustanoveními Směrnice 1999/5/EC.
Dansk [Danish]:	Dette udstyr er i overensstemmelse med de væsentlige krav og andre relevante bestemmelser i Direktiv 1999/5/EF.
Deutsch [German]:	Dieses Gerät entspricht den grundlegenden Anforderungen und den weiteren entsprechenden Vorgaben der Richtlinie 1999/5/EU.
Eesti [Estonian]:	See seade vastab direktiivi 1999/5/EU olulistele nõuetele ja teistele asjakohastele sätetele.
English:	This equipment is in compliance with the essential requirements and other relevant provisions of Directive 1999/5/EC.
Español [Spanish]:	Este equipo cumple con los requisitos esenciales así como con otras disposiciones de la Directiva 1999/5/CE.
Ελληνική [Greek]:	Αυτός ο εξοπλισμός είναι σε συμμόρφωση με τις ουσιαστικές απαιτήσεις και άλλες σχετικές διατάξεις της Οδηγίας 1999/5/EC.
Français [French]:	Cet appareil est conforme aux exigences essentielles et aux autres dispositions pertinentes de la Directive 1999/5/EC.
Íslenska [Icelandic]:	Þetta tæki er samkvæmt grunnkröfum og öðrum viðeigandi ákvæðum Tilskipunar 1999/5/EC.
Italiano [Italian]:	Questo apparato è conforme ai requisiti essenziali ed agli altri principi sanciti dalla Direttiva 1999/5/CE.
Latviski [Latvian]:	Šī iekārta atbilst Direktīvas 1999/5/EK būtiskajām prasībām un citiem ar to saistītajiem noteikumiem.
Lietuvių [Lithuanian]:	Šis įrenginys tenkina 1999/5/EB Direktyvos esminius reikalavimus ir kitas šios direktyvos nuostatas.
Nederlands [Dutch]:	Dit apparaat voldoet aan de essentiële eisen en andere van toepassing zijnde bepalingen van de Richtlijn 1999/5/EC.
Malti [Maltese]:	Dan l-apparat huwa konformi mal-ftigiet essenzjali u l-provedimenti l-oħra rilevanti tad-Direttiva 1999/5/EC.
Magyar [Hungarian]:	Ez a készülék teljesíti az alapvető követelményeket és más 1999/5/EK irányelvben meghatározott vonatkozó rendelkezéseket.
Norsk [Norwegian]:	Dette utstyret er i samsvar med de grunnleggende krav og andre relevante bestemmelser i EU-direktiv 1999/5/EF.
Polski [Polish]:	Urządzenie jest zgodne z ogólnymi wymaganiami oraz szczególnymi warunkami określonymi Dyrektywą UE: 1999/5/EC.
Português [Portuguese]:	Este equipamento está em conformidade com os requisitos essenciais e outras provisões relevantes da Directiva 1999/5/EC.
Română [Romanian]:	Acest echipament este în conformitate cu cerințele esențiale și cu alte prevederi relevante ale Directivei 1999/5/EC.
Slovensko [Slovenian]:	Ta naprava je skladna z bistvenimi zahtevami in ostalimi relevantnimi pogoji Direktive 1999/5/EC.
Slovensky [Slovak]:	Toto zariadenie je v zhode so základnými požiadavkami a inými príslušnými nariadeniami direktív: 1999/5/EC.
Suomi [Finnish]:	Tämä laite täyttää direktiivin 1999/5/EY olennaiset vaatimukset ja on siinä asetettujen muiden laitetta koskevien määräysten mukainen.
Svenska [Swedish]:	Denna utrustning är i överensstämmelse med de väsentliga kraven och andra relevanta bestämmelser i Direktiv 1999/5/EC.

CE Compliance

Note: The full declaration of conformity for this product can be found at http://www.cisco.com/web/consumer/support/compliance_info.html.

The following standards were applied during the assessment of the product against the requirements of the Directive 1999/5/EC:

- Radio: EN 300 328
- EMC: EN 301 489-1 and EN 301 489-17
- Safety: EN 60950 and EN 50385

The CE mark and class-2 identifier are affixed to the product and its packaging. This product conforms to the following European directives:



National Restrictions

This product is for indoor use only.

France

For 2.4 GHz, the output power is restricted to 10 mW EIRP when the product is used outdoors in the band 2454 - 2483.5 MHz. There are no restrictions when used in other parts of the 2.4 GHz band. Check <http://www.arcep.fr/> for more details.

Pour la bande 2,4 GHz, la puissance est limitée à 10 mW en p.i.r.e. pour les équipements utilisés en extérieur dans la bande 2454 - 2483,5 MHz. Il n'y a pas de restrictions pour des utilisations dans d'autres parties de la bande 2,4 GHz. Consultez <http://www.arcep.fr/> pour de plus amples détails.

Italy

This product meets the National Radio Interface and the requirements specified in the National Frequency Allocation Table for Italy. Unless this wireless LAN product is operating within the boundaries of the owner's property, its use requires a "general authorization." Please check <http://www.comunicazioni.it/it/> for more details.

Questo prodotto è conforme alle specifiche di Interfaccia Radio Nazionali e rispetta il Piano Nazionale di ripartizione delle frequenze in Italia. Se non viene installato all'interno del proprio fondo, l'utilizzo di prodotti Wireless LAN richiede una "Autorizzazione Generale". Consultare <http://www.comunicazioni.it/it/> per maggiori dettagli.

Latvia

The outdoor usage of the 2.4 GHz band requires an authorization from the Electronic Communications Office. Please check <http://www.esd.lv> for more details.

2,4 GHz frekvenču joslas izmantošanai ārpus telpām nepieciešama atļauja no Elektronisko sakaru direkcijas. Vairāk informācijas: <http://www.esd.lv>.

Note: The regulatory limits for maximum output power are specified in EIRP. The EIRP level of a device can be calculated by adding the gain of the antenna used (specified in dBi) to the output power available at the connector (specified in dBm).

Antennas

Use only the antenna supplied with the product.

EU Compliance

This device complies with Commission Regulations (EU) No. 1275/2008 and 801/2013. For more information on the energy consumption of this product, go to www.cisco.com/go/cpe-eu-lot26-results.

About This Guide

Introduction

Welcome. This guide provides instructions and recommendations for placing, installing, configuring, operating, maintaining, and troubleshooting the DPC3928 (with or without a battery) and EPC3928 DOCSIS Wireless Residential Voice Gateways.

Purpose

This guide covers the following product models:

- DPC3928 DOCSIS Wireless Residential Voice Gateway (with or without a battery)
- EPC3928 DOCSIS Wireless Residential Voice Gateway

All features described in this guide are standard to these models of residential gateways unless otherwise noted. For the purpose of this guide, whenever a feature or option applies to only a specific model, the model number is specified. If a model number is not specified, then the feature or option applies to both of the models.

Audience

This guide is written for the home subscriber.

Document Version

This is the second formal release of this document. In addition to minor text and graphic changes, changes have been made to add information about the DPC3928 with battery option and to provide information about compliance with Commission Regulations (EU) No. 1275/2008 and 801/2013.

1

Introducing the DOCSIS Wireless Residential Voice Gateway

Introduction

This chapter provides an overview of residential gateway features, indicators, and connectors to help you become familiar with the residential gateway and the benefits it offers. This chapter also lists the accessories and equipment that are provided with the residential gateway so that you can verify that you received all of these items.

In This Chapter

■ Introduction	2
■ What's In the Carton?	3
■ Front Panel Description	4
■ Back Panel Description	6

Introduction

Your new Cisco® Model DPC3928 DOCSIS® 3.0 or EPC3928 EuroDOCSIS™ Wireless Residential Gateway with Embedded Digital Voice Adapter is a cable modem that meets industry standards for high-speed data connectivity along with reliable digital telephone service. The DPC3928 and EPC3928 residential gateway delivers data, voice and wired (Ethernet) or wireless gateway capabilities to connect a variety of devices in the home or small office and support high-speed data access and cost-effective voice services, all in one device.

This guide provides procedures and recommendations for placing, installing, configuring, operating, and troubleshooting your DPC3928 and EPC3928 residential gateway for high-speed Internet and digital telephone service for your home or office. Refer to the appropriate section in this guide for the specific information you need for your situation. Contact your service provider for more information about subscribing to these services.

Your new residential gateway offers the following outstanding benefits and features:

- Compliant with DOCSIS and EuroDOCSIS 3.0, 2.0, and 1.x standards along with PacketCable™ and EuroPacketCable™ specifications to deliver high-end performance and reliability
- High performance broadband Internet connectivity to energize your online experience
- Two-line embedded digital voice adapter for wired telephony service
- Four 1000/100/10BASE-T Ethernet ports to provide wired connectivity
- 802.11n Wireless Access Point
- User configurable Parental Control blocks access to undesirable Internet sites
- Advanced firewall technology deters hackers and protects the home network from unauthorized access
- Attractive compact design that allows for vertical, horizontal, or wall-mounted operation
- Color-coded interface ports and corresponding cables simplify installation and setup
- DOCSIS-5 compliant LED labeling and behavior provides a user and technician friendly method to check operational status and act as a troubleshooting tool
- Allows automatic software upgrades by your service provider

What's In the Carton?

When you receive your residential gateway, you should check the equipment and accessories to verify that each item is in the carton and that each item is undamaged. The carton contains the following items:



One DPC3928 or EPC3928 DOCSIS Wireless Residential Voice Gateway (no battery)



Or one DPC3928 (with battery)



One Ethernet cable (May not be provided with all products.)



One USB cable (Image may vary from actual product. May not be provided with all products.)



One Lithium Ion cartridge battery (Image may vary from product. May not be provided with all products.)



One power adapter (models requiring external power supply)

If any of these items are missing or damaged, please contact your service provider for assistance.

Notes:

- You need an optional cable signal splitter and additional standard RF coaxial cables if you want to connect a VCR, a Digital Home Communications Terminal (DHCT) or a set-top converter, or a TV to the same cable connection as your residential gateway.
- If your product supports telephone service, cables and other equipment needed for telephone service must be purchased separately. Contact your service provider to inquire about the equipment and cables you need for telephone service.

Front Panel Description

The front panel of your residential gateway provides LED status indicators that indicate how well and at what state your residential gateway is operating. See *Operation of Front Panel Indicators* (on page 21), for more information on front panel LED status indicator functions.

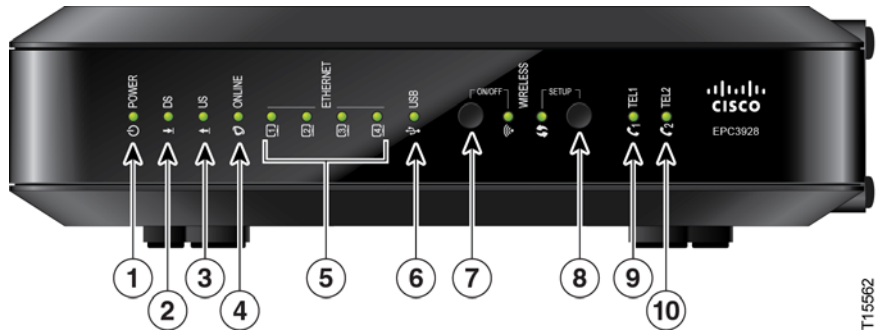

EPC3928 (model shown without battery backup capability)

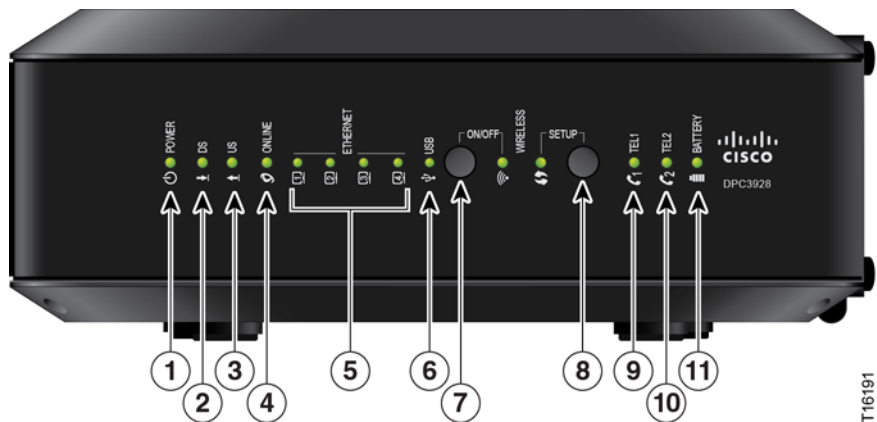

DPC3928 (model shown with battery backup capability)

- 1 **POWER**—ON, power is applied to the residential gateway
- 2 **DS**—ON, the residential gateway is receiving data from the cable network
- 3 **US**—ON, the residential gateway is sending data to the cable network
- 4 **ONLINE**—ON, the residential gateway is registered on the network and fully operational
- 5 **ETHERNET 1 - 4**—ON, a device is connected to one of the Ethernet ports. BLINKING indicates that data is being transferred over the Ethernet connection
- 6 **USB**—ON, a device is connected to the USB port. BLINKING indicates that data is being transferred over the USB connection

- 7 **WIRELESS ON/OFF** (Optional) – Press this button to activate and turn on the Wireless feature. This feature allows users to transfer data over the wireless connection. When the WIRELESS indicator is ON, it indicates that the Wireless Access Point is operational. BLINKING indicates that data is being transferred over the wireless connection. OFF indicates that the Wireless feature has been disabled.
- 8 **WIRELESS SETUP** – Press this button to activate the Wireless Setup feature. This feature allows users to add new Wireless Protected Setup (WPS) compliant wireless clients to the home network. When the SETUP indicator is OFF (normal condition), it indicates that the wireless setup is not active. BLINKING indicates the user has activated wireless setup to add new wireless clients on the wireless network.
- 9 **TEL1** – ON indicates telephony service is enabled. Blinks when line 1 is in use. OFF indicates that phone service for TEL 1 is not enabled
- 10 **TEL2** – ON indicates telephony service is enabled. Blinks when line 2 is in use. OFF indicates that phone service for TEL 2 is not enabled
- 11 **BATTERY (optional model only)** – ON indicates the battery is charged. Blinking indicates the battery charge is low. OFF indicates the unit is operating from battery power, the battery charge is depleted, or the battery is defective or missing

Notes:

- After the residential gateway is successfully registered on the network, the POWER, DS, US, and ONLINE LEDs illuminate continuously to indicate that the residential gateway is active and fully operational.
- The high-speed data operation is disabled when operating on battery power; only the telephone service (if available on this model) is active when operating on battery power.
- LEDs may behave differently when the residential gateway is running on battery power (without AC power). Most LEDs are disabled if the unit is operating on battery power. In this mode, the POWER LED blinks to indicate that the unit is operating under battery power.
- The residential gateway should only run on battery power when AC power has failed. If the POWER LED indicates that the unit is running on battery power, but the AC power has not failed, verify that the power cord is plugged into a working AC outlet.

Back Panel Description

The following illustration identifies the back panel components on the DPC3928 and EPC3928 residential gateways. Descriptions for each component follow the illustration.

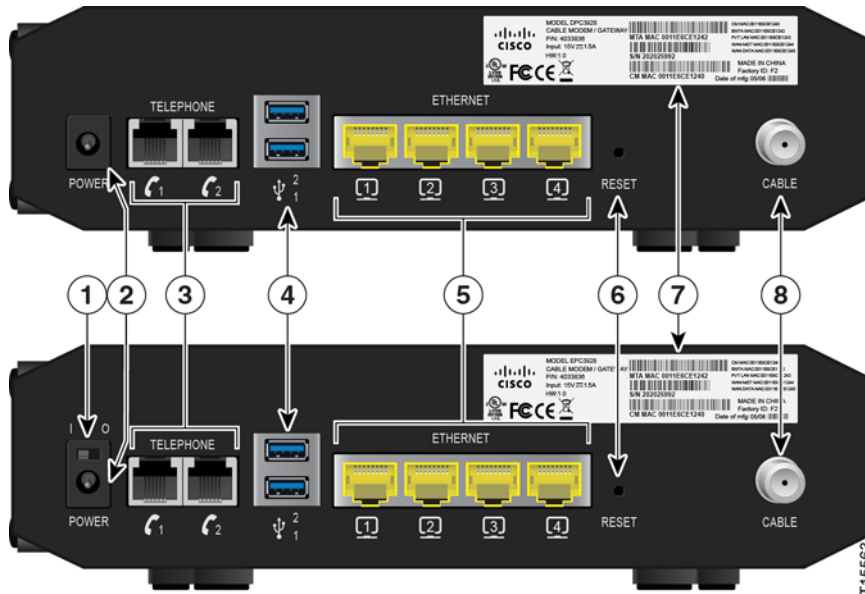

The following illustration shows the back panel of the DPC3928 with battery backup capability.

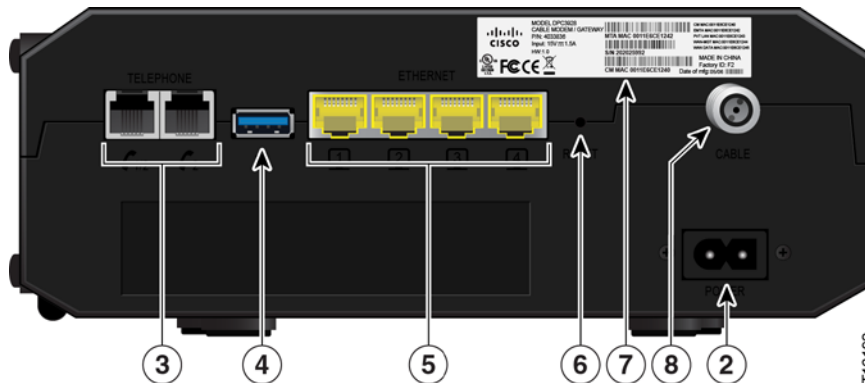

Important: Do not connect your PC to both the Ethernet and USB ports at the same time. Your residential gateway will not function properly if both the Ethernet and USB ports are connected to your PC at the same time.

- 1 ON/OFF SWITCH (Provided only on products that carry the CE mark) –** Allows you to turn off of the residential gateway without removing the power cord. Turning the residential gateway off using this switch ensures that the unit is consuming no energy.

- 2 **POWER**—Connects the residential gateway to the AC power adapter that is provided with your residential gateway
Important: Use only the power supply provided with your residential gateway.
 - 3 **TELEPHONE 1 and 2**—RJ-11 telephone ports connect to home telephone wiring to conventional telephones or fax machines. (Products shipping in North America support lines 1 and 2 on port 1 when used with a two-line phone.)
 - 4 **USB (Optional for some models)**—Connects to selected devices. For models that support USB, the default is one USB port.
 - 5 **ETHERNET**—Four RJ-45 Ethernet ports connect to the Ethernet port on your PC or your home network
 - 6 **RESET**—A momentary pressing (1-2 seconds) of this button performs a software reset the device. Pressing and holding the button for more than ten seconds first causes a reset-to-factory-default of all settings and then performs a software reset of the device
-  **CAUTION:**
The RESET button is for maintenance purposes only. Do not use unless instructed to do so by your service provider. Doing so may cause you to lose any settings you have selected.
- 7 **MAC ADDRESS LABEL**—Displays the CM, EMTA, and WAN MAC addresses for the residential gateway
 - 8 **CABLE**—F-connector connects to an active cable signal from your service provider

2

Installing the DOCSIS Wireless Residential Voice Gateway

Introduction

This chapter describes how to properly install the residential gateway and connect the residential gateway to a computer and other devices.

In This Chapter

- Installation Preparations10
- Install the Wireless Residential Voice Gateway18

Installation Preparations

Before installing the residential gateway, make sure that your system meets or exceeds the requirements listed in this section. Also, make sure that you have prepared your home and home devices as described in this section.

What Are the System Requirements for Internet Service?

To ensure that your residential gateway operates efficiently for high-speed Internet service, you must have an Internet-capable PC, Mac, or Internet appliance equipped with an Ethernet port or Wi-Fi capability.

Note: You will also need an active cable input line and an Internet connection.

What Are the Requirements for Telephone Service?

If you intend to use the residential gateway for digital telephone service, verify that your home meets or exceeds all of the following requirements.

Maximum Number of Telephones

The RJ-11 telephone-style connectors on the residential gateway can each provide telephone service to multiple telephones, fax machines, and analog modems.

The maximum number of telephone devices connected to each RJ-11 port is limited by the total Ringing Load of the telephone devices that are connected. Many telephone devices are marked with a Ringer Equivalent Number (REN). Each telephone port on the residential gateway can support up to a 5 REN load.

The sum of the REN load on all of the telephone devices attached to each port must not exceed 5 REN.

Telephone Device Types

You can use telephone devices that are not labeled with a REN number, but the maximum number of attached telephone devices cannot be accurately calculated. With telephone devices that are not labeled, each device should be connected and the ring signal should be tested before adding more devices. If too many telephone devices are attached and the ring signal can no longer be heard, telephone devices should be removed until the ring signal works properly.

Telephones, fax machines, and other telephone devices use the center 2 pins of the RJ-11 connectors to connect to your primary service. The outer 2 pins of the connector may be provisioned to provide a second telephone line. Contact your service provider for more information.

Dialing Requirements

All of your telephones should be set to use Dual-Tone Multi-Frequency (DTMF) dialing. Pulse dialing may not be supported by your local service provider.

Telephone Wiring Requirements

The residential gateway supports connecting to the interior telephone wiring as well as connecting directly to a telephone or fax machine. The maximum distance from the unit to the most distant telephone device must not exceed 1000 feet (300 meters). Use 26-gauge twisted-pair, or larger, telephone wiring.

Important: Connection to an existing or a new permanently installed home telephone wiring network should be completed by a qualified installer or at the direction of your telephone service provider.

What Types of Service Accounts Do I Need?

Depending upon the features that your service provider offers, you may need to establish one or both of the following accounts:

- A high-speed Internet access account, if your residential gateway supports an Internet connection
- An account for telephone service, if your residential gateway supports digital telephone service

Refer to one of the following topics to learn more about the types of service accounts that you may need to establish.

High-Speed Internet Access Account

If you do *not* have a high-speed Internet access account, your service provider will set up your account and become your Internet service provider (ISP). Internet access enables you to send and receive email, access the World Wide Web, and receive other Internet services.

You will need to give your service provider information about the residential gateway to use the high-speed Internet feature that this product offers. See *Information Your Service Provider Needs* (on page 12) to learn how to locate the information your service provider needs to establish a high-speed Internet access account for the residential gateway.

If you have an existing high-speed Internet access account, you will need to give your service provider the serial number and MAC address of the residential gateway to use the high-speed Internet feature that this product offers. See *Information Your Service Provider Needs* (on page 12) to learn how to locate this information.

Chapter 2 Installing the DOCSIS Wireless Residential Voice Gateway

Information Your Service Provider Needs

You will need to give your service provider the following information, which is printed on the bar code label attached to the device:

- The Serial Number (S/N) of the residential gateway. The serial number consists of a series of nine digits.
- The Media Access Control (CM MAC) address of the residential gateway. The CM MAC address consists of a series of 12 alphanumeric characters.
- The Media Access Control (MAC) address of the residential gateway media terminal adapter (MTA MAC). The MTA MAC address consists of a series of 12 alphanumeric characters.

The following illustration shows a typical bar coded label; the image may vary from the label on the actual product.

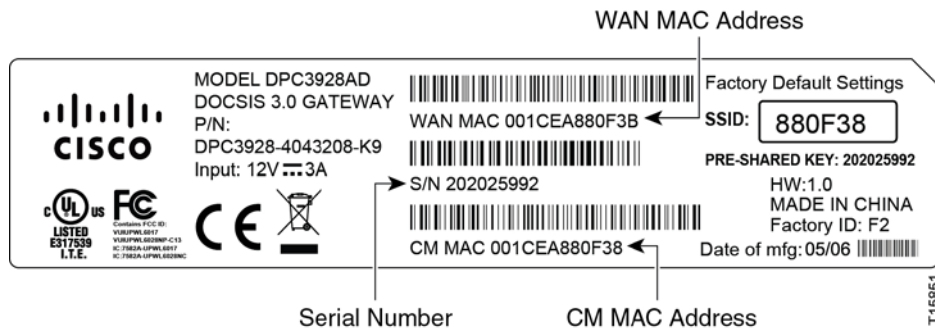

Write down these numbers in the spaces provided:

Serial Number _____

CM MAC Address _____

MTA MAC Address _____

I Already Have a High-Speed Internet Access Account

Telephone Service

You will need to establish a telephone account with your local service provider to use your residential gateway for telephone service.

When you contact your service provider, you may be able to transfer your existing telephone numbers. If not, then your cable telephony service provider will assign a new telephone number to enable your voice service(s). Discuss these options with your telephony service provider.

Where Is the Best Location for My Wireless Residential Voice Gateway?

The ideal location for your residential gateway is where it has access to outlets and other devices. Think about the layout of your home or office, and consult with your service provider to select the best location for your residential gateway. Read this user guide thoroughly before you decide where to place your residential gateway.

Consider these recommendations:

- Choose a location close to your computer if you will also use the residential gateway for high-speed Internet service.
- Choose a location that is near an existing RF coaxial connection to eliminate the need for an additional RF coaxial outlet.
- Choose a location that is relatively protected from accidental disturbance or harm, such as a closet, basement, or other protected area.
- Choose a location so that there is plenty of room to guide the cables away from the residential gateway without straining or crimping them.
- Choose a location that allows adequate ventilation around the residential gateway.
- Choose a location for the residential gateway that is adjacent to your telephone equipment if you plan on connecting your phone directly to the residential gateway.

Note: If you are using the residential gateway to provide service to several telephones, a professional installer can connect the residential gateway to your existing home telephone wiring.

Install the Battery

Your residential gateway may include one rechargeable Lithium-Ion battery to provide stand-by operation in the event of an AC power failure. We recommend that you install the battery before mounting the residential gateway to a wall (if you decide to do so) and before installing the residential gateway in your home.

It is possible to use the residential gateway without the battery. However, if you choose to operate the residential gateway without a battery, you will not have telephone service during a power outage.

For information on battery maintenance, see *Maintaining the Battery* (on page 27).

Installing the Battery

Installing the battery requires no tools. Follow these instructions to install the battery.



WARNING:

Fully charged high-capacity rechargeable batteries should be handled with care. Replace only with the battery recommended by the manufacturer. Do not disassemble it or attempt to recharge the battery outside the system. Do not crush, puncture, dispose of in a fire, short the external contacts, or expose to high temperature or immerse in water or other liquids. Dispose of the battery in accordance with local regulations and instructions from your service provider.

- 1 Turn the residential gateway so that you are facing the side with the battery compartment.
- 2 Gently release the latch to open the battery cover and gain access to the battery compartment.
- 3 Insert the battery into the battery compartment. Do not force the battery into the compartment, but be sure to press the battery all the way in until it seats fully.
Important: Take care to position the battery correctly. Insert the battery only as shown in the following illustration.

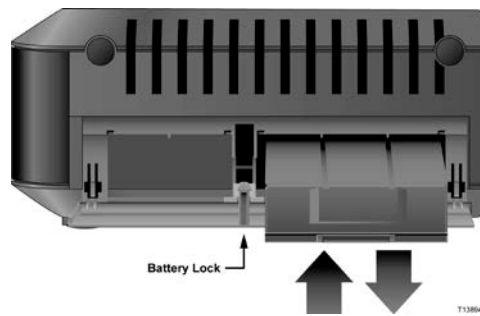

- 4 Close the battery compartment door.
Important: After you install the residential gateway and plug it into an AC electrical outlet as described in *Install the Wireless Residential Voice Gateway* (on page 18), it can take as long as 24 hours for the battery to charge fully. However, you can begin using your high-speed Internet and telephone service immediately after installation. See *Normal Operations (AC Power Applied)* (on page 24) for information on how the LEDs on the front of the residential gateway indicate the state of the battery charge.

How Do I Mount the Wireless Residential Voice Gateway on a Wall? (Optional)

Your residential gateway may include mounting holes so that, if you wish, you can mount the residential gateway to a wall. This section describes how to mount the residential gateway to a wall, and includes a list of the equipment that you will need along with suggestions for choosing an appropriate place to mount the residential gateway.

Important: If you have not already done so, insert the battery in the residential gateway before you mount the residential gateway on a wall (if desired) or before you install the residential gateway in your home. For assistance inserting the battery in the residential gateway, see *Install the Battery* (on page 13).

Select an Appropriate Place to Mount the Wireless Residential Voice Gateway

You may mount the residential gateway to a wall that is made of cement, wood, or drywall. When choosing an appropriate mounting place, refer to the following recommendations:

- Ensure that the mounting location is free of obstructions on all sides, and the cables should be able to easily reach the residential gateway without strain.
- Leave sufficient clearance between the bottom of the residential gateway and any flooring or shelving underneath to allow access to cabling.
- Allow enough slack in all cables so that the residential gateway can be removed for any required maintenance without disconnecting the cables.
- Choose a location that allows adequate ventilation around the residential gateway.

Equipment Needed

Verify that you have the following items that you will need to mount the residential gateway:

- Two wall anchors for #8 x 1-inch screws
- Two #8 x 1-inch pan head sheet metal screws
- Drill with a 3/16-in. wood or masonry bit, as appropriate for the wall composition
- A copy of the wall-mounting illustrations shown on the following pages

Position the Wireless Residential Voice Gateway

Use the following illustrations to guide you in positioning the residential gateway on the wall.

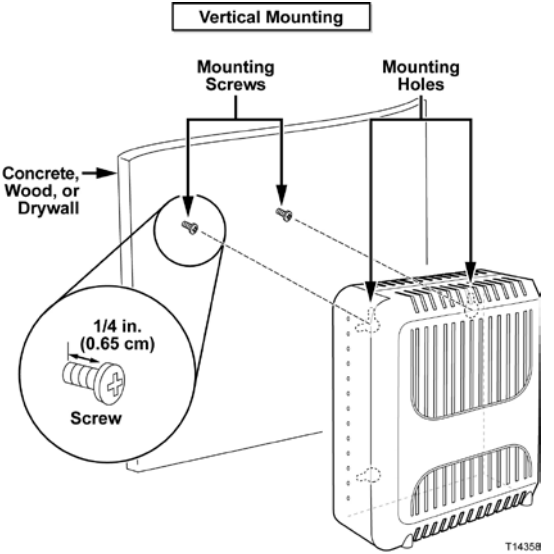
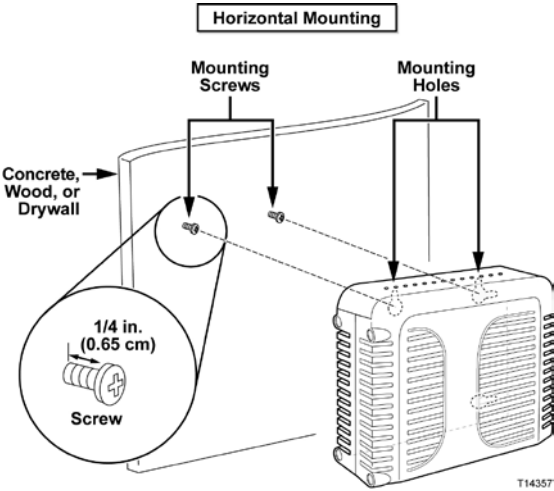

Location and Dimensions of the Wall-Mounting Slots

The following illustration shows the location and dimensions of the wall-mounting slots on the bottom of the residential gateway. Use this illustration as a guide for mounting the residential gateway to the wall.

Note: Image not to scale.

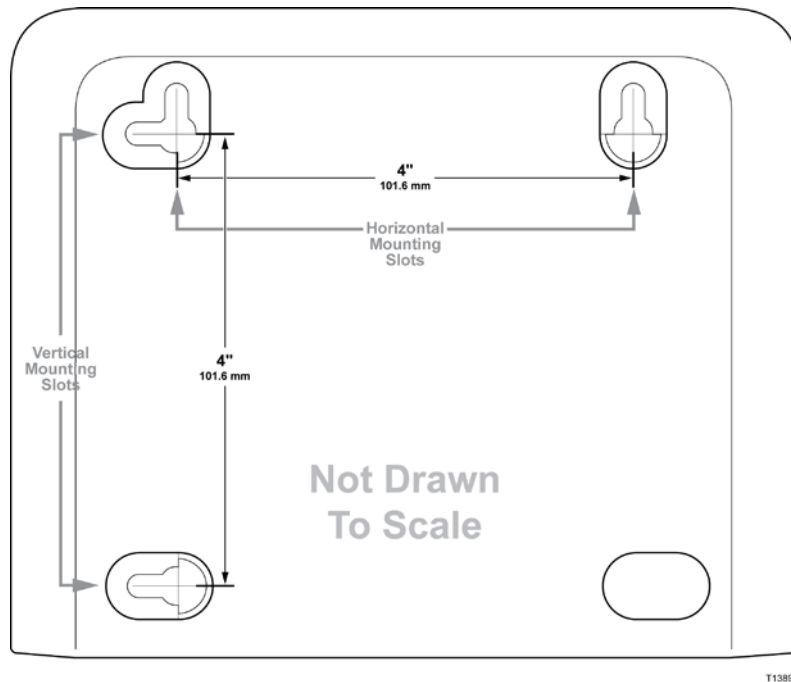

Mounting the Wireless Residential Voice Gateway on a Wall

- 1 Using a drill with a 3/16-inch bit, drill two holes at the same height and 4 inches apart.

Note: The preceding graphic illustrates the location of the mounting holes on the back of the residential gateway.
- 2 Are you mounting the residential gateway into a drywall or concrete surface where a wooden stud is available?
 - If **yes**, go to step 3.
 - If **no**, drive the anchor bolts into the wall, and install the mounting screws into the anchor bolts; leave a gap of about 1/4-inch between the screw head and the wall. Then, go to step 4.
- 3 Install the mounting screws into the wall; leave a gap of about 1/4-inch between the screw head and the wall. Then, go to step 4.
- 4 Verify that no cables or wires are connected to the residential gateway.
- 5 Lift the residential gateway into position. Slip the large end of both mounting slots (located in the back of the residential gateway) over the mounting screws, and then slide the residential gateway down until the narrow end of the keyhole slot contacts the screw shaft.

Important: Verify that the mounting screws securely support the residential gateway before you release the unit.

Install the Wireless Residential Voice Gateway

This section describes how to connect your residential gateway to support the services that the residential gateway offers.

Important: If you have not already done so, insert the battery in the residential gateway before you mount the residential gateway on a wall (if desired) or before you install the residential gateway in your home. For assistance inserting the battery in the residential gateway, see *Install the Battery* (on page 13).

Connect Devices to the Wireless Residential Voice Gateway

The following illustration shows all of the possible connections that can be made to your residential gateway for various services. Although your model may not support all of the services pictured, you can determine which services your model supports by referring to the Benefits and Features list in *Introduction* (on page 2).

Notes:

- Professional installation may be available. Contact your local service provider for further assistance.
- Device image varies according to model.

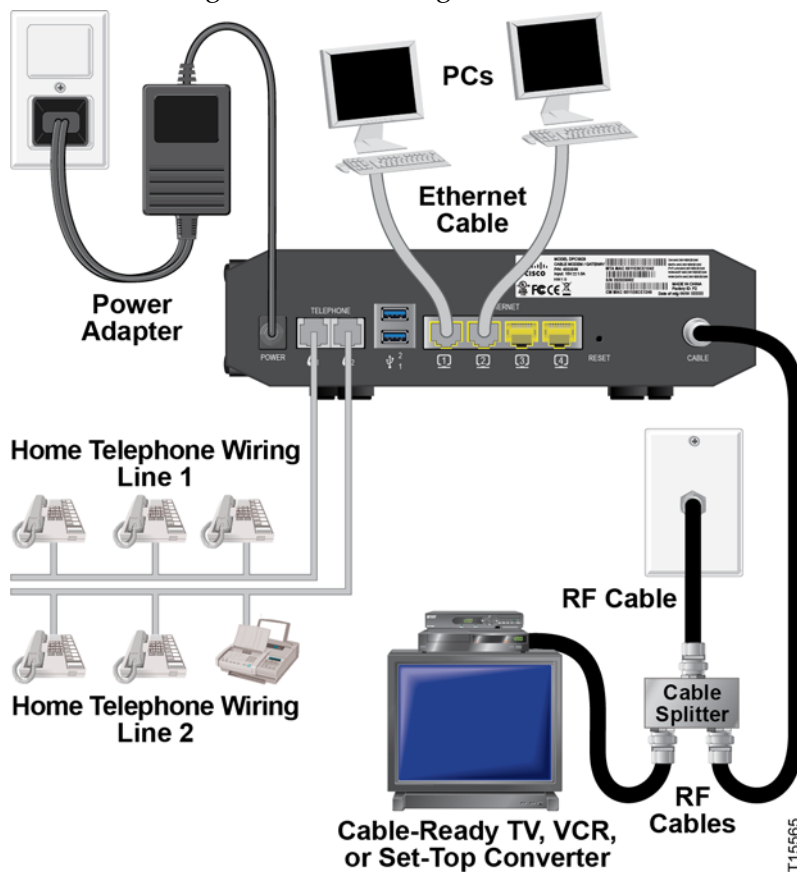

Connect the Wireless Residential Voice Gateway

The following installation procedure ensures proper setup and configuration for the residential gateway.

- 1 Choose an appropriate and safe location to install the residential gateway (close to a power source, an active cable connection, and your PC-if using high-speed Internet). For assistance, go to *Where Is the Best Location for My Wireless Residential Voice Gateway?* (on page 13).



WARNING:

- To avoid personal injury, follow the installation instructions in the exact order shown.
- Wiring and connections must be properly insulated to prevent electrical shock.
- Disconnect power from the residential gateway before attempting to connect to any device.

- 2 Power off your PC and other networking device; then, unplug them from the power source.
- 3 Connect the active RF coaxial cable from your service provider to the coax connector labeled **CABLE** on the back of the residential gateway.

Note: To connect a TV, DHCT, set-top, or VCR from the same cable connection, you will need to install a cable signal splitter (not included). Always check with your service provider before using a splitter as a splitter may degrade the signal.

- 4 Connect your PC to the residential gateway using either of the following connections:
 - **Ethernet Connection:** Locate the yellow Ethernet cable, connect one end of the Ethernet cable to the Ethernet port on your PC, and connect the other end to the yellow **ETHERNET** port on the back of the residential gateway.

Note: To install more Ethernet devices than ports provided on the residential gateway, use an external multi-port Ethernet switch(s).
 - **Wireless:** Make sure that your wireless device is powered up. You will need to associate your wireless device with the wireless residential gateway once the residential gateway is operational. Follow the directions provided for your wireless device for associating with a wireless access point. If the residential gateway has a WIRELESS ON/OFF button, make sure that WIRELESS is enabled by confirming that the ON/OFF indicator is ON. If the indicator is OFF, press the ON/OFF button to enable the WIRELESS feature.

More information about the factory default configuration of your wireless residential gateway can be found later in this guide in Configure Wireless Settings.

- 5 Locate the AC power cord provided with your residential gateway. Insert one end of the power cord into the AC connector on the back of the residential gateway. Then, plug the AC power cord into an AC outlet to power-up the residential gateway. The residential gateway will perform an automatic search to locate and sign on to the broadband data network. This process may take up to 2-5 minutes. The residential gateway will be ready for use when the **POWER**, **DS**, **US** and **ONLINE** LEDs on the front panel of the residential gateway stop blinking and remain on continuously.
- 6 Plug in and power on your PC and other home network devices. The **LINK** LED on the residential gateway corresponding to the connected devices should be on or blinking.
- 7 Once your residential gateway is online, most Internet devices will have immediate Internet access.

Note: If your PC does not have Internet access, refer to *How Do I Configure TCP/IP Protocol?* (on page 32) for information on how to configure your PC for TCP/IP. For Internet devices other than PCs, refer to the DHCP or IP Address configuration section of the User Guide or Operations Manual for those devices.

3

Operation of Front Panel Indicators

Introduction

This chapter describes the behavior of the front panel indicators when the residential gateway is first powered up, during normal operations, and in special conditions.

In This Chapter

- Initial Power On, Calibration, and Registration (AC Power applied)22
- Normal Operations (AC Power Applied)24
- Special Conditions26

Initial Power On, Calibration, and Registration (AC Power applied)

The following chart illustrates the sequence of steps and the corresponding appearance of the residential gateway front panel LED status indicators during power up, calibration, and registration on the network when AC power is applied to the residential gateway. Use this chart to troubleshoot the power up, calibration, and registration process of your residential gateway.

Note: After the residential gateway completes Step 7 (Data Network Registration Complete), the residential gateway proceeds immediately to Normal Operations. See *Normal Operations (AC Power applied)* (on page 24).

Front Panel LED Status Indicators During Initial Power Up, Calibration, and Registration							
Part 1, High Speed Data Registration							
Step:	1	2	3	4	5	6	
Front Panel Indicator	Self Test	Downstream Scan	Downstream Signal Lock	Ranging	Requesting IP Address	Request High Speed Data Provisioning File	
1	POWER	On	On	On	On	On	On
2	DS	On	Blinking	On	On	On	On
3	US	On	Off	Off	Blinking	On	On
4	ONLINE	On	Off	Off	Off	Off	Blinking
5	ETHERNET 1-4	On	On or Blinking	On or Blinking	On or Blinking	On or Blinking	On or Blinking
6	USB	On	On or Blinking	On or Blinking	On or Blinking	On or Blinking	On or Blinking
7	WIRELESS ON/OFF	Off	On or Blinking	On or Blinking	On or Blinking	On or Blinking	On or Blinking
8	WIRELESS SETUP	Off	On or Blinking	On or Blinking	On or Blinking	On or Blinking	On or Blinking
9	TEL 1	On	Off	Off	Off	Off	Off
10	TEL 2	On	Off	Off	Off	Off	Off
11	BATTERY (Optional for some models)	<ul style="list-style-type: none"> ■ On - When battery is charged ■ Blinks - When battery charge is low ■ Off - When there is no battery in the unit 					

Initial Power On, Calibration, and Registration (AC Power applied)

Front Panel LED Status Indicators During Initial Power Up, Calibration, and Registration						
Part 2, Telephone Registration						
Step:		7	8	9	10	11
Front Panel Indicator		Data Network Registration Complete	Requesting Telephone IP Address	Request Telephone Provisioning File	Restarting Voice Service	Telephone Registration Complete
1	POWER	On	On	On	On	On
2	DS	On	On	On	On	On
3	US	On	On	On	On	On
4	ONLINE	On	On	On	On	On
5	ETHERNET 1-4	On	On or Blinking	On or Blinking	On or Blinking	On or Blinking
6	USB	On or Blinking	On or Blinking	On or Blinking	On or Blinking	On or Blinking
7	WIRELESS ON/OFF	On or Blinking	On or Blinking	On or Blinking	On or Blinking	On or Blinking
8	WIRELESS SETUP	Off	Off	Off	On or Blinking	On or Blinking
9	TEL 1	Off	Blinking	Off	Blinking	On
10	TEL 2	Off	Off	Blinking	Blinking	On
11	BATTERY (Optional for some models)	<ul style="list-style-type: none"> ■ On - When battery is charged ■ Blinks - When battery charge is low ■ Off - When there is no battery in the unit 				

Normal Operations (AC Power Applied)

The following chart illustrates the appearance of the residential gateway front panel LED status indicators during normal operations when AC power is applied to the gateway.

Front Panel LED Status Indicators During Normal Conditions		
Front Panel Indicator		Normal Operations
1	POWER	On
2	DS	On
3	US	On
4	ONLINE	On
5	ETHERNET 1-4	<ul style="list-style-type: none"> ■ On - When a single device is connected to the Ethernet port and no data is being sent to or from the residential gateway ■ Blinks - When only one Ethernet device is connected and data is being transferred between the consumer premise equipment (CPE) and the wireless home gateway ■ Off - When no devices are connected to the Ethernet ports
6	USB	<ul style="list-style-type: none"> ■ On - When a single device is connected to the USB port and no data is being sent to or from the modem ■ Blinks - When only one USB device is connected and data is being transferred between the consumer premise equipment (CPE) and the wireless home gateway ■ Off - When no devices are connected to the USB ports
7	WIRELESS ON/OFF	<ul style="list-style-type: none"> ■ On - When the wireless access point is enabled and operational ■ Blinks - When data is being transferred between the CPE and the wireless home gateway ■ Off - When the wireless access point is disabled by the user
8	WIRELESS SETUP	<ul style="list-style-type: none"> ■ Off - When wireless setup is not active ■ Blinks - When wireless setup is active to add new wireless clients on the wireless network
9	TEL 1	<ul style="list-style-type: none"> ■ On - When telephony service is enabled ■ Blinks - When line 1 is in use
10	TEL 2	<ul style="list-style-type: none"> ■ On - When telephony service is enabled ■ Blinks - When line 2 is in use

Front Panel LED Status Indicators During Normal Conditions		
Front Panel Indicator		Normal Operations
11	BATTERY (Optional for some models)	<ul style="list-style-type: none"> ■ On - When battery is charged ■ Blinks - When battery charge is low ■ Off - When there is no battery in the unit

Note: In addition to the status shown in the previous table, some service providers use color-coded LEDs to indicate detailed channel bonding and data link status. For additional information about color-coded LEDs, check with your service provider.

Special Conditions

The following chart describes the appearance of the residential gateway front panel LED status indicators during special conditions to show when you have been denied network access.

Front Panel LED Status Indicators During Special Conditions		
Front Panel Indicator		Network Access Denied
1	POWER	Slow Blinking (once per second)
2	DS	Slow Blinking (once per second)
3	US	Slow Blinking (once per second)
4	ONLINE	Slow Blinking (once per second)
5	ETHERNET 1-4	Slow Blinking (once per second)
6	USB	Slow Blinking (once per second)
7	WIRELESS ON/OFF	Slow Blinking (once per second)
8	WIRELESS SETUP	Slow Blinking (once per second)
9	TEL 1	Off
10	TEL 2	Off
11	BATTERY (Optional for some models)	On

4

Maintaining the Battery

Introduction

This chapter describes how to maintain and replace the battery that is included with the residential gateway.

In This Chapter

- Location of the Battery28
- Battery Maintenance29

Location of the Battery

The following illustration shows the location of the battery.

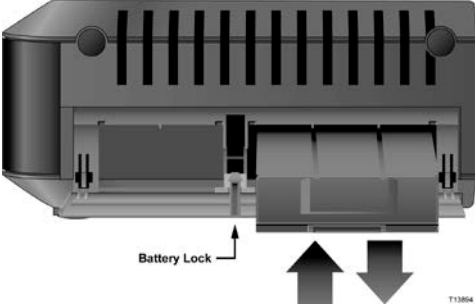

Battery Maintenance

If your residential gateway contains a battery backup feature, a high-capacity rechargeable battery provides stand-by operation in the event of an AC power failure. You can replace the battery without the use of any tools.

**WARNING:**

Fully charged high-capacity rechargeable batteries should be handled with care. Replace only with the battery recommended by the manufacturer. Do not disassemble it or attempt to recharge the battery outside the system. Do not crush, puncture, dispose of in a fire, short the external contacts, or expose to high temperature or immerse in water or other liquids. Dispose of the battery in accordance with local regulations and instructions from your service provider.

Charging the Battery

The battery begins to charge automatically as soon as you attach the residential gateway to the AC electrical outlet. When you first plug in the residential gateway, the **POWER** LED status indicator illuminates.

Important: It may take as long as 24 hours for the battery to charge fully.

Removing and Replacing the Battery

Under normal circumstances, the battery should last for several years. The **BATTERY** LED status indicator turns off to indicate that the battery should be replaced soon. Contact your service provider to obtain replacement batteries and for disposal instructions.

Follow these steps to remove and replace the battery. You can remove and replace the battery without disconnecting the AC power source.

- 1 Turn the residential gateway so that you are facing the side with the battery compartment.
- 2 Gently release the latch to open the battery cover and gain access to the battery compartment.
- 3 Grasp the plastic strip on the front of the battery and gently slide the battery forward to remove it from the battery compartment.

Chapter 4 Maintaining the Battery

- 4 Insert a new battery into the battery compartment. Do not force the battery into the compartment, but be sure to press the battery all the way in until it seats fully.

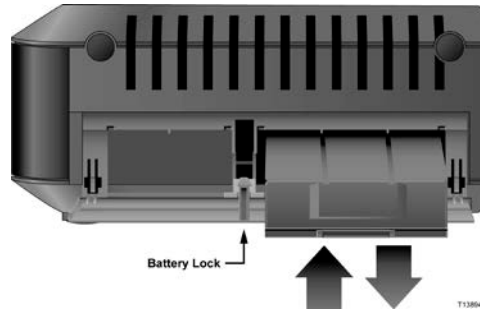

- 5 Close the battery compartment door. The battery lock will automatically re-engage.

Important: It can take as long as 24 hours for the battery to charge fully.

Note: Dispose of the battery in accordance with local regulations and instructions from your service provider.

Using the Wireless Residential Voice Gateway Without a Battery

If you want, you can use the residential gateway without a battery. If you need to remove the battery, follow the procedures found in *Removing and Replacing the Battery* (on page 29).

Important: If you choose to operate your residential gateway without a battery, you risk losing your telephone service during a power outage.

5

Troubleshooting the DOCSIS Wireless Residential Voice Gateway

Introduction

This chapter describes the most common issues that may occur after the residential gateway is installed and provides possible solutions and tips for improved performance of the residential gateway.

In This Chapter

- Frequently Asked Questions32
- Common Troubleshooting Issues37
- Tips for Improved Performance39

Frequently Asked Questions

This section provides answers to common questions about the residential gateway.

How Do I Configure TCP/IP Protocol?

To configure TCP/IP protocol, you need to have an Ethernet Network Interface Card (NIC) with TCP/IP communications protocol installed on your system. TCP/IP is a communications protocol used to access the Internet. This section contains instructions for configuring TCP/IP on your Internet devices to operate with the residential gateway in Microsoft Windows or Macintosh environments.

TCP/IP protocol in a Microsoft Windows environment is different for each operating system. Follow the appropriate instructions in this section for your operating system.

Configuring TCP/IP on Windows 7 Systems

- 1 Open **Network Connections** by clicking the **Start** button, and then clicking **Control Panel**.
- 2 In the Search field, type **adapter**, and then, under **Network and Sharing Center**, click **View network connections**.
- 3 Right-click the connection that you want to change, and then click **Properties**. If you are prompted for an administrator password or confirmation, type the password or provide confirmation. The Local Area Connection Properties window appears.
- 4 Click the **Networking** tab.
- 5 Under **This connection uses the following items**, click either **Internet Protocol Version 4 (TCP/IPv4)** or **Internet Protocol Version 6 (TCP/IPv6)**, and then click **Properties**.
- 6 To specify IPv4 IP address settings, do one of the following:
 - To get IP settings automatically using DHCP, click **Obtain an IP address automatically**, and then click **OK**.
 - To specify an IP address, click **Use the following IP address**, and then, in the **IP address**, **Subnet mask**, and **Default gateway** fields, type the IP address settings.
- 7 To specify IPv6 IP address settings, do one of the following:
 - To get IP settings automatically using DHCP, click **Obtain an IPv6 address automatically**, and then click **OK**.
 - To specify an IP address, click **Use the following IPv6 address**, and then, in the **IPv6 address**, **Subnet prefix length**, and the **Default gateway** fields, type the IP address settings.

- 8 To specify DNS server address settings, do one of the following:
 - To get a DNS server address automatically using DHCP, click **Obtain DNS server address automatically**, and then click **OK**.
 - To specify a DNS server address, click **Use the following DNS server addresses**, and then, in the **Preferred DNS server** and **Alternate DNS server** fields, type the addresses of the primary and secondary DNS servers.
- 9 To change advanced DNS, WINS, and IP settings, click **Advanced**.
- 10 When you are finished, click **OK**.
- 11 Try to access the Internet. If you cannot access the Internet, contact your service provider for further assistance.

Configuring TCP/IP on Windows XP Systems

- 1 Click **Start**, and depending on your Start menu setup, choose one of the following options:
 - If you are using the Windows XP Default Start menu, choose **Connect to**, choose **Show all connections**, and then go to Step 2.
 - If you are using the Windows XP Classic Start menu, select **Settings**, choose **Network Connections**, click **Local Area Connection**, and then go to Step 3.
- 2 Double-click the **Local Area Connection** icon in the LAN or High-Speed Internet section of the Network Connections window.
- 3 Click **Properties** in the Local Area Connection Status window.
- 4 Click **Internet Protocol (TCP/IP)**, and then click **Properties** in the Local Area Connection Properties window.
- 5 Select both **Obtain an IP address automatically** and **Obtain DNS server address automatically** in the Internet Protocol (TCP/IP) Properties window, and then click **OK**.
- 6 Click **Yes** to restart your computer when the Local Network window appears. The computer restarts. The TCP/IP protocol is now configured on your PC, and your Ethernet devices are ready for use.
- 7 Try to access the Internet. If you cannot access the Internet, contact your service provider for further assistance.

Configuring TCP/IP on Macintosh Systems

- 1 Click the **Apple** icon in the upper-left corner of the Finder. Scroll down to **Control Panels**, and then click **TCP/IP**.
- 2 Click **Edit** on the Finder at the top of the screen. Scroll down to the bottom of the menu, and then click **User Mode**.
- 3 Click **Advanced** in the User Mode window, and then click **OK**.
- 4 Click the Up/Down selector arrows located to the right of the Connect Via section of the TCP/IP window, and then click **Using DHCP Server**.

- 5 Click **Options** in the TCP/IP window, and then click **Active** in the TCP/IP Options window.
Note: Make sure that the **Load only when needed option** is *unchecked*.
- 6 Verify that the **Use 802.3** option located in the upper-right corner of the TCP/IP window is unchecked. If there is a check mark in the option, uncheck the option, and then click **Info** in the lower-left corner.
- 7 Is there a Hardware Address listed in this window?
 - If **yes**, click **OK**. To close the TCP/IP Control Panel window, click **File**, and then scroll down to click **Close**. You have completed this procedure.
 - If **no**, you must power off your Macintosh.
- 8 With the power off, simultaneously press and hold down the **Command (Apple)**, **Option**, **P**, and **R** keys on your keyboard. Keeping those keys pressed down, power on your Macintosh but do not release these keys until you hear the Apple chime at least three times, then release the keys and let the computer restart.
- 9 When your computer fully reboots, repeat Steps 1 through 7 to verify that all TCP/IP settings are correct. If your computer still does not have a Hardware Address, contact your authorized Apple dealer or Apple technical support center for further assistance.

How Do I Renew the IP Address on My PC?

If your PC cannot access the Internet after the residential gateway is online, it is possible that your PC did not renew its IP address. Follow the appropriate instructions in this section for your operating system to renew the IP address on your PC.

Renewing the IP Address on Windows 7 Systems

- 1 Click the Windows **Start** button.
- 2 Type **cmd** in the Search field. The cmd window appears.
- 3 Type **ipconfig/renew** and press **Enter** to renew the IP address of the computer.

Renewing the IP Address on Windows XP Systems

- 1 Click **Start**, and then click **Run**. The Run window appears.
- 2 Type **cmd** in the Open field and click **OK**. A window with a command prompt appears.
- 3 Type **ipconfig/release** at the C:/ prompt and press **Enter**. The system releases the IP address.
- 4 Type **ipconfig/renew** at the C:/ prompt and press **Enter**. The system displays a new IP address.

- 5 Click the **X** in the upper-right corner of the window to close the Command Prompt window. You have completed this procedure.

Note: If you cannot access the Internet, contact your service provider for further assistance.

Renewing the IP Address on Macintosh Systems

- 1 Close all open programs.
- 2 Open your **Preferences** folder.
- 3 Drag the **tcp/ip preferences** file to the Trash.
- 4 Close all open windows and empty the Trash.
- 5 Restart your computer.
- 6 As your computer starts, simultaneously press and hold down the **Command (Apple)**, **Option, P**, and **R** keys on your keyboard. Keeping those keys pressed down, power on your Macintosh but do not release these keys until you hear the Apple chime at least three times, release the keys and let the computer restart.
- 7 When your computer fully reboots, click the **Apple** icon in the upper-left corner of the Finder. Scroll down to **Control Panels**, and then click **TCP/IP**.
- 8 Click **Edit** on the Finder at the top of the screen. Scroll down to the bottom of the menu, and then click **User Mode**.
- 9 Click **Advanced** in the User Mode window, and then click **OK**.
- 10 Click the Up/Down selector arrows located to the right of the Connect Via section of the TCP/IP window, and then click **Using DHCP Server**.
- 11 Click **Options** in the TCP/IP window, and then click **Active** in the TCP/IP Options window.

Note: In some cases, the **Load only when needed** option does not appear. If it appears, select the option. A check mark appears in the option.
- 12 Verify that the **Use 802.3** option located in the upper-right corner of the TCP/IP window is not selected. If there is a check mark in the option, select the option to clear the check mark, and then click **Info** in the lower-left corner.
- 13 Is there a Hardware Address listed in this window?
 - If **yes**, click **OK**. To close the TCP/IP Control Panel window, click **File**, and then scroll down to click **Close**.
 - If **no**, repeat these instructions from Step 6.
- 14 Reboot your computer.

What if I Do Not Subscribe to Cable TV?

If cable TV is available in your area, data service may be made available with or without subscribing to cable TV service. Contact your local service provider for complete information on cable services, including high-speed Internet access.

How Do I Arrange for Installation?

Call your service provider to inquire about professional installation. A professional installation ensures proper cable connection to the residential gateway and to your PC, and it ensures the proper configuration of all hardware and software settings. Contact your service provider for more information about installation.

How Does the Wireless Residential Voice Gateway Connect to My Computer?

The residential gateway connects to the 10/100/1000BASE-T Ethernet port on your PC. To use the Ethernet interface, your PC needs Ethernet cards. These cards are available from your local PC or office supply retailer, or from your service provider. For best performance over an Ethernet connection, your PC should be equipped with a Gigabit Ethernet card.

After My Wireless Residential Voice Gateway Is Connected, How Do I Access the Internet?

Your local service provider becomes your Internet service provider (ISP). They offer a wide range of services including email, chat, news, and information services. Your service provider will provide the software that you will need.

Can I Watch TV and Surf the Internet at the Same Time?

Absolutely! If you subscribe to cable television service, you can watch TV and use your residential gateway at the same time by connecting your TV and your residential gateway to the cable network using an optional cable signal splitter.

Can I Use my Existing Phone Number with the Wireless Residential Voice Gateway?

Telephone numbers are portable in some areas. Contact your telephone service provider for more information about using an existing telephone number.

How Many Telephones Can I Connect?

The RJ-11 telephone-style connectors on the residential gateway can each provide telephone service to multiple telephones, fax machines, and analog modems. The maximum number of telephone devices connected to each RJ-11 port is limited by the total Ringing Load of the telephone devices that are connected. Many telephone devices are marked with a Ringer Equivalent Number (REN). Each telephone port on the residential gateway can support up to a 5 REN load. The sum of the REN load on all of the telephone devices attached to each port must not exceed 5 REN.

Common Troubleshooting Issues

This section describes common problems and offers solutions.

I don't understand the front panel status indicators

See *Operation of Front Panel Indicators* (on page 21), for more detailed information on front panel LED status indicator operation and function.

The Wireless Residential Voice Gateway does not register an Ethernet connection

Try one of the following solutions:

- Verify that your computer has an Ethernet card and that the Ethernet driver software is properly installed. If you purchase and install an Ethernet card, follow the installation instructions very carefully.
- Verify the status of the front panel status indicator lights.

The Wireless Residential Voice Gateway does not register an Ethernet connection after connecting to a hub

If you are connecting multiple PCs to the residential gateway, you should first connect the residential gateway to the uplink port of the hub using the correct crossover cable. The LINK LED of the hub will illuminate continuously.

The Wireless Residential Voice Gateway does not register a cable connection

The residential gateway works with a standard, 75-ohm, RF coaxial cable. If you are using a different cable, your residential gateway will not function properly. Contact your service provider to determine whether you are using the correct cable.

There is no dial tone when I lift the handset

Try the following solutions if you cannot hear a dial tone:

- Your telephone wiring may be connected to the wrong RJ-11 port on the residential gateway. The residential gateway has two telephone ports. Verify that you are connected to the correct telephone port.
- There may be a problem with your telephone set. Use a different telephone set and listen to hear dial tone.

Chapter 5 Troubleshooting the DOCSIS Wireless Residential Voice Gateway

- There may be a problem with your home telephone wiring. Use a telephone and connect directly to the same RJ-11 port on the back of the unit. If the dial tone is working here but does not work at other locations in the home, a professional may need to diagnose and repair a problem with your telephone wiring.
- Verify that the telephone company has removed the previous telephone service from your home telephone wiring.
- Your telephone service may not be enabled from your cable telephony service provider. Contact your cable telephony service provider for more information.

Tips for Improved Performance

If your residential gateway does not perform as expected, the following tips may help. If you need further assistance, contact your service provider.

- Verify that the plug to your residential gateway AC power is properly inserted into an electrical outlet.
- Verify that your residential gateway AC power cord is not plugged into an electrical outlet that is controlled by a wall switch. If a wall switch controls the electrical outlet, make sure the switch is in the **ON** position.
- Verify that the **ONLINE** LED status indicator on the front panel of your residential gateway is illuminated.
- Verify that your cable service is active and that it supports two-way service.
- Verify that all cables are properly connected, and that you are using the correct cables.
- If you are using the Ethernet connection, verify that your TCP/IP is properly installed and configured.
- Verify that you have called your service provider and given them the serial number and MAC address of your residential gateway.
- If you are using a cable signal splitter so that you can connect the residential gateway to other devices, remove the splitter and reconnect the cables so that the residential gateway is connected directly to the cable input. If the residential gateway now functions properly, the cable signal splitter may be defective and may need to be replaced.
- If you are connected to your PC with an Ethernet connection, your PC should be equipped with a Gigabit Ethernet card for best performance.

6

Customer Information

Introduction

If you have technical questions, call Cisco Services for assistance. Follow the menu options to speak with a service engineer.

Access your company's extranet site to view or order additional technical publications. For accessing instructions, contact the representative who handles your account. Check your extranet site often as the information is updated frequently.



Americas Headquarters

Cisco Systems, Inc.
170 West Tasman Drive
San Jose, CA 95134-1706
USA

<http://www.cisco.com>
Tel: 408 526-4000
800 553-6387
Fax: 408 527-0883

This document includes various trademarks of Cisco Systems, Inc. Please see the Notices section of this document for a list of the Cisco Systems, Inc. trademarks used in this document.

Product and service availability are subject to change without notice.

© 2013-2014 Cisco and/or its affiliates. All rights reserved.
December 2014

Part Number OL-29161-02