

Touchstone® TM602 Telephony Modem User's Guide

Get ready to experience the Internet's express lane! Whether you're checking out streaming media, downloading new software, checking your email, or talking with friends on the phone, the Touchstone TM602 Telephony Modem brings it all to you faster and more reliably. All while providing toll quality Voice over IP telephone service. Some models even provide a Lithium-Ion battery backup to provide continued telephone service during power outages.

The Touchstone Telephony Modem provides an Ethernet connection for use with either a single computer or home/office Local Area Network (LAN). Some Telephony Modems also provide a USB connection. You can connect two separate computers at the same time using both of these connections. In addition, the Touchstone Telephony Modem provides for up to two separate lines of telephone service.

Installation is simple and your cable company will provide assistance to you for any special requirements. The links below provide more detailed instructions.

[Safety Requirements](#)

[Getting Started](#)

[Battery Installation and Replacement \(TM602G/H Models Only\)](#)

[Installing and Connecting Your Telephony Modem](#)

[Installing USB Drivers on Your PC](#)

[Configuring Your Ethernet Connection](#)

[Using the Telephony Modem](#)

[Troubleshooting](#)

[Glossary](#)

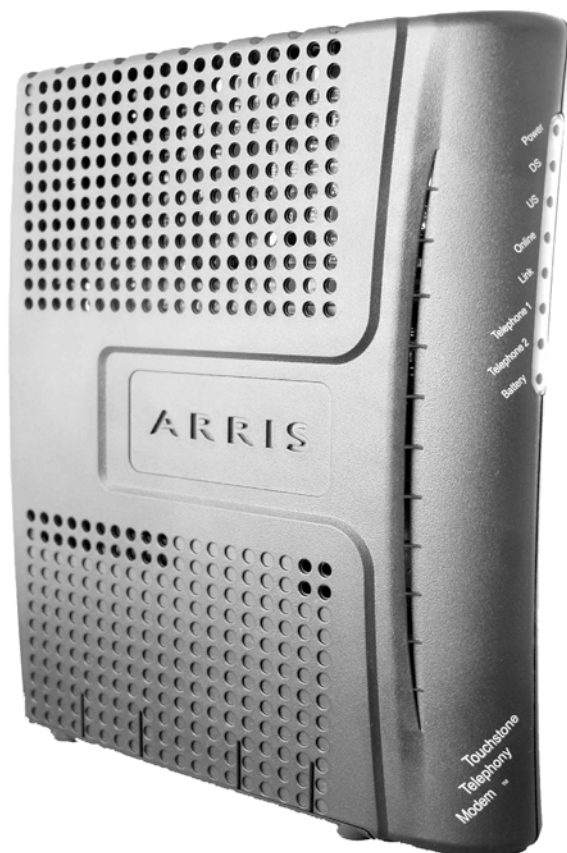

Export Regulations

This product may not be exported outside the U.S. and Canada without U.S. Department of Commerce, Bureau of Export Administration authorization. Any export or re-export by the purchaser, directly or indirectly, in contravention of U.S. Export Administration Regulation is prohibited.

Copyright © 2005–2007 ARRIS Group, Inc. Patents pending. All rights reserved.

The information in this document is subject to change without notice. The statements, configurations, technical data, and recommendations in this document are believed to be accurate and reliable, but are presented without express or implied warranty. Users must take full responsibility for their applications of any products specified in this document. The information in this document is proprietary to ARRIS.

ARRIS, Touchstone, and the ARRIS logo are trademarks or registered trademarks of ARRIS Group. All other trademarks and registered trademarks are the property of their respective holders.

Release 6 Standard 1.0 August 2007

Safety Requirements

ARRIS Telephony Modems comply with the applicable requirements for performance, construction, labeling, and information when used as outlined below:



CAUTION

Potential equipment damage Potential loss of service

Connecting the Telephony Modem to existing telephone wiring should only be performed by a professional installer. Physical connections to the previous telephone provider must be removed and the wiring must be checked; there must not be any voltages. Cancellation of telephone service is not adequate. Failure to do so may result in loss of service and/or permanent damage to the Telephony Modem.

- The Telephony Modem is designed to be connected directly to a telephone.
 - Connecting the Telephony Modem to the home's existing telephone wiring should only be performed by a professional installer.
 - Do not use product near water (i.e. wet basement, bathtub, sink or near a swimming pool, etc.), to avoid risk of electrocution.
 - Avoid using and/or connecting the equipment during an electrical storm, to avoid risk of electrocution.
 - Do not locate the equipment within 6 feet (1.9 m) of a flame or ignition source, to avoid damage or injury from battery explosion (i.e. heat registers, space heaters, fireplaces, etc.).
 - Use only power supply and power cord included with the equipment.
 - Equipment should be installed near the power outlet and should be easily accessible.
- The shield of the coaxial cable must be connected to earth (grounded) at the entrance to the building in accordance with applicable national electrical installation codes. In the U.S., this is required by NFPA 70 (National Electrical Code) Article 820. In the European Union and in certain other countries, CATV installation equipotential bonding requirements are specified in IEC 60728-11, *Cable networks for television signals, sound signals and interactive services*, Part 11: Safety. This equipment is intended to be installed in accordance with the requirements of IEC 60728-11 for safe operation.
- If the equipment is to be installed in an area serviced by an IT power line network, as is found in many areas of Norway, special attention should be given that the installation is in accordance with IEC 60728-11, in particular Annex B and Figure B.4.
- In areas of high surge events or poor grounding situations and areas prone to lightning strikes, additional surge protection may be required (i.e. PF11VNT3 from American Power Conversion) on the AC, RF, Ethernet and Phone lines.
 - When the Telephony Modem is connected to a local computer through USB or Ethernet cables, the computer must be properly grounded to the building/residence AC ground network. All plug-in cards within the computer must be properly installed and grounded to the computer frame per the manufacturer's specifications.



European Compliance

This product complies with the provisions of the Electromagnetic Compatibility (EMC) Directive (89/336/EEC), the Amending Directive (92/31/EEC), the Low Voltage Directive (73/23/EEC), and the CE Marking Directive (93/68/EEC). As such, this product bears the CE marking in accordance with the above applicable Directive(s).

A copy of the Declaration of Conformity may be obtained from: ARRIS International, Inc., 3871 Lakefield Drive, Suite 300, Suwanee, GA 30024.



As indicated by this symbol, disposal of this product or battery is governed by Directive 2002/96/EC of the European Parliament and of the Council on waste electrical and electronic equipment (WEEE). WEEE could potentially prove harmful to the environment; as such, upon disposal of the Telephony Modem the Directive requires that this product must not be disposed as unsorted municipal waste, but rather collected separately and disposed of in accordance with local WEEE ordinances.

This product complies with directive 2002/95/EC of the European Parliament and of the Council of 27 January 2003 on the restriction of the use of certain hazardous substances (RoHS) in electrical and electronic equipment.



Getting Started

About Your New Telephony Modem

The Touchstone TM602 Telephony Modem is DOCSIS[®] or Euro-DOCSIS[™] compliant with the following features:

- Speed: much faster than dialup or ISDN service
- Convenience: supports USB and Ethernet; both can be used simultaneously
- Flexibility: provides two independent lines of telephone service as well as high speed data
- Compatibility: supports tiered data services (if offered by your cable company)

What's in the Box?

Make sure you have the following items before proceeding. Call your cable company for assistance if anything is missing.

- Telephony Modem
- Power Cord
- Quick Installation Guide
- USB Cable
- Ethernet Cable
- CD-ROM
- Screws for Wall Mounting the Unit
- End User License Agreement

What's on the CD?

The CD provides the following items:

- Quick Install Guide
- User's Guide
- USB Drivers (Windows 2000/XP/Vista)
- Remove USB Driver Utility



Items You Need

If you are installing the Telephony Modem yourself, make sure you have the following items on hand before continuing:

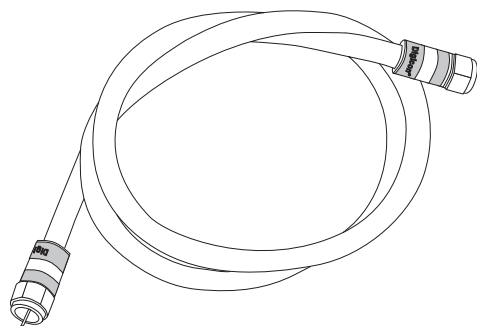

Coax Cable

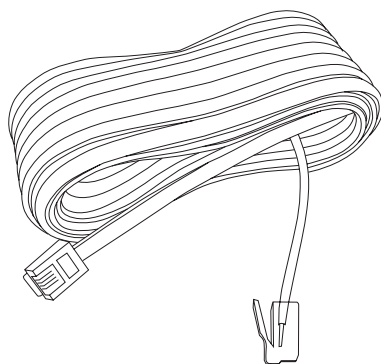

Phone Cable

- **Telephony modem package:** see [What's in the Box?](#) for a list of items in the package.
- **Coaxial cable (coax):** as shown in the image to the left, this is a thin cable with a connector on each end. It is the same kind of wire used to connect to your television for cable TV. You can buy coax from any electronics retailer and many discount stores; make sure it has connectors on both ends. There are two types of connectors, slip-on and screw-on; the screw-on connectors are best for use with your Telephony Modem. The coax should be long enough to reach from your Telephony Modem to the nearest cable outlet.
- **Phone Cable:** as shown in the image to the left, this is a standard phone cable with standard phone connectors (RJ11 type) on both ends. You can buy phone cables from any electronics retailer and many discount stores.
- **Splitter (optional):** provides an extra cable connection by splitting a single outlet into two. You may need a splitter if you have a TV already connected to the cable outlet that you want to use. You can buy a splitter from any electronics retailer and most discount stores; you may also need a short piece of coax cable (with connectors); use it to connect the splitter to the cable outlet and then connect the Telephony Modem and TV to the splitter.

Note: A splitter effectively cuts the signal in half and sends each half to its two outputs. Using several splitters in a line may deteriorate the quality of your television, telephone, and/or internet connection.
- **Information packet:** your cable company should furnish you with a packet containing information about your service and how to set it up. Read this information carefully and contact your cable company if you have any questions.



Getting Service

Before trying to use your new Telephony Modem, contact your local cable company to establish an Internet account and telephone service. When you call, have the following information ready:

- the Telephony Modem serial number and MAC addresses of the unit (printed on a sticker on the bottom of the Telephony Modem)
- the model number of the Telephony Modem

Save this information for future use. In addition, you should ask your cable company the following questions:

- Do you have any special system requirements or files that I need to download after I am connected?
- When can I start using my Telephony Modem?
- Do I need a user ID or password to access the Internet or my e-mail?
- Will my phone number(s) change?
- What new calling features will I have and how do I use them?



System Requirements

The Touchstone Telephony Modem operates with most computers. The following describes requirements for each operating system; see the documentation for your system for details on enabling and configuring networking.

To use the Telephony Modem, you need DOCSIS high-speed Internet service from your cable company.

Windows

Ethernet connection: Windows 98, Windows 98 SE (Second Edition), Windows ME, Windows 2000, Windows XP, or Windows Vista

USB connection: Windows 2000, Windows XP, or Windows Vista

MacOS

Ethernet connection only: System 7.5 to MacOS 9.2 (Open Transport recommended) or MacOS X

Linux/other Unix

Ethernet connection only: Hardware drivers, TCP/IP, and DHCP must be enabled in the kernel

About this Manual

This manual covers all of the different TM602 models. Your model may not have all of the capabilities outlined in this manual. To determine which model you have purchased, refer to the image at the left. The model number is on the label affixed to the Telephony Modem.

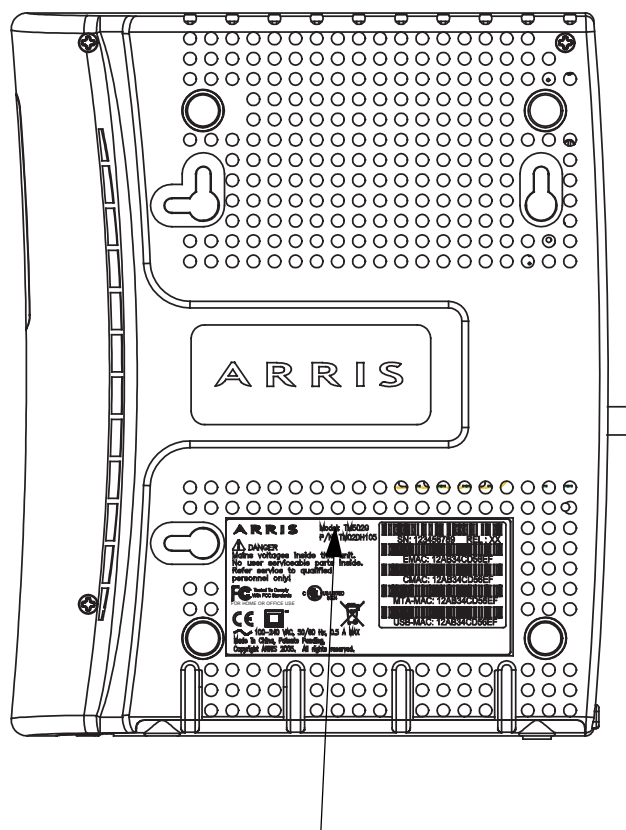

Model Number



Ethernet or USB?

There are two ways to connect your computer (or other equipment) to the Telephony Modem. The following will help you decide which is best for you:

Ethernet

Ethernet is a standard method of connecting two or more devices into a Local Area Network (LAN). Use the Ethernet connection if your computer has built-in Ethernet hardware, does not use Windows, or you want to share the Telephony Modem connection with several computers.

Note: To connect two or more computers to the Ethernet port, you will need a hub or broadband router (available at computer retailers).

The Telephony Modem package comes with a 6-foot (1.9m) Ethernet cable (the connectors look like wide telephone connectors); you can purchase more cables if necessary at a computer retailer. If you are connecting the Telephony Modem directly to a computer, or to an Ethernet hub or broadband router with a cross-over switch, ask for Category 5 (CAT5) straight-through cable. If you are connecting the Telephony Modem to an Ethernet hub or broadband router without a crossover switch, ask for a Category 5 crossover cable.

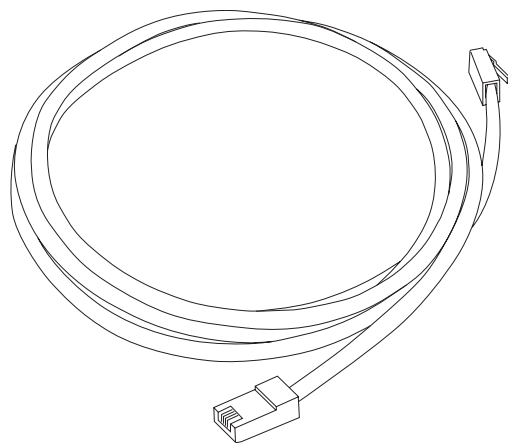

Ethernet Cable

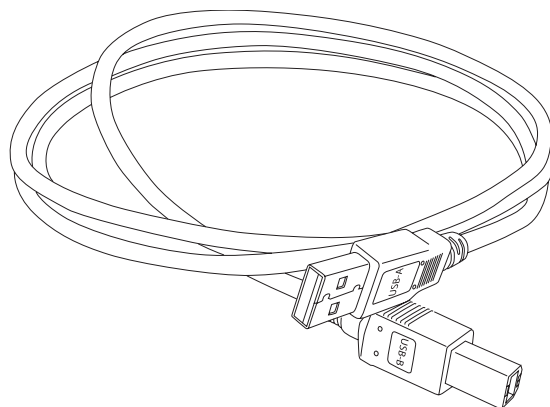

USB Cable

USB

USB (Universal Serial Bus) is meant for connecting a variety of accessories, such as keyboards, mice, printers, and communications devices (including Telephony Modems) to a single computer. Use the USB connection if you have only one computer, and the computer is using a Windows operating system (Windows 2000 or later), and has no built-in Ethernet hardware. The Telephony Modem package comes with a 5-foot (1.6m) USB cable.

Both

If you have two or more computers, you can connect one computer to the Telephony Modem's USB port and one or more other computers to the Ethernet port. To connect two or more computers to the Ethernet port, you will need a hub or broadband router (available at computer retailers).

For more information about connecting two or more computers, contact your cable service provider.



What About Security?

Having a high-speed, always-on connection to the Internet requires a certain amount of responsibility to other Internet users—including the need to maintain a reasonably secure system. While no system is 100% secure, you can use the following tips to enhance your system's security:

- Keep your operating system updated with the latest security patches. Run the system update utility at least weekly.
- Keep your email program updated with the latest security patches. In addition, avoid opening email containing attachments, or opening files sent through chat rooms, whenever possible.
- Install a virus checker and keep it updated.
- Avoid providing web or file-sharing services over your Telephony Modem. Besides certain vulnerability problems, most cable companies prohibit running servers on consumer-level accounts and may suspend your account for violating your terms of service.
- Use the cable company's mail servers for sending email.
- Avoid using [proxy](#) software unless you are certain that it is not open for abuse by other Internet users (some are shipped open by default). Criminals can take advantage of open proxies to hide their identity when breaking into other computers or sending spam. If you have an open proxy, your cable company may suspend your account to protect the rest of the network.
- If you connect your Telephony Modem to a wireless LAN, make sure you enable security and encryption on the wireless hub (for the same reasons that you should run only secured proxies). Consult the documentation and technical support of the wireless equipment provider for help.



Battery Installation and Replacement (TM602G/H Models Only)

2-cell Battery



TM602G and TM602H Telephony Modems may optionally include one of three types of Lithium-Ion batteries: a 2-cell battery, a 4-cell battery, or an 8-cell battery.

For safety and regulatory purposes, batteries are shipped outside of the Telephony Modem and must be installed.

Identify the battery type using the photos to the left and use the proper installation procedure:

- [TM602G/H 2-cell Battery Installation and Replacement](#)

Note: The 2-cell battery may be light grey or black.

- [TM602G/H 4-cell Battery Installation and Replacement](#)

Note: The 4-cell battery is longer than the 2-cell battery, and has a strap between the guides.

- [TM602G/H 8-cell Battery Installation and Replacement](#)

Note: The 8-cell battery replaces the battery door, and increases the height of the Telephony Modem by about 5/8inch (16 mm).

4-cell Battery



8-cell Battery



TM602G/H 2-cell Battery Installation and Replacement

This model of the Telephony Modem has the ability to provide battery backup in the event of a local power loss. The battery backup is not intended to take the place of AC power. Use this procedure to install and to replace the backup batteries.

Action

- 1 Insert a finger into the latch opening, press down and pull back on the latch holding the battery door (on the bottom of the Telephony Modem). Pull the door toward you. Set the door aside in a safe place.

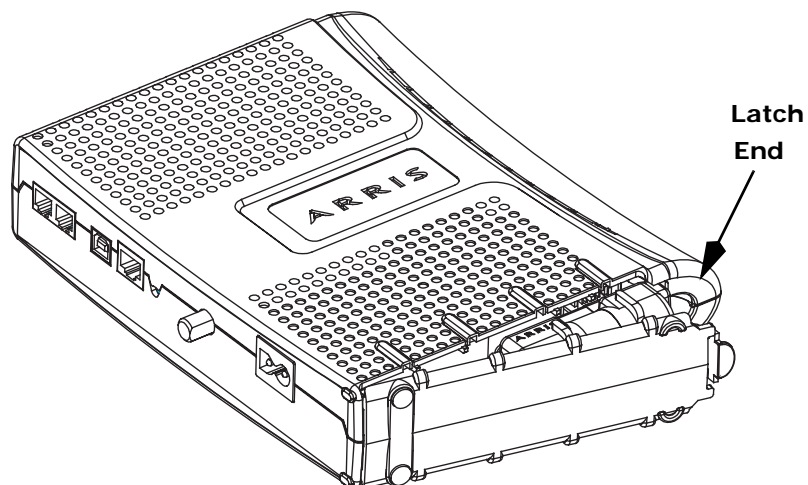

- 2 Hold the battery pack so that the guides on the battery align with the slots on the Telephony Modem and slide the battery into the bay. The diagram on the left shows the proper orientation.

Note: Batteries will not insert completely into the Telephony Modem if not oriented correctly. The battery should slide into the bay without significant force. Line up the slots in the battery bay with the guides on the battery.

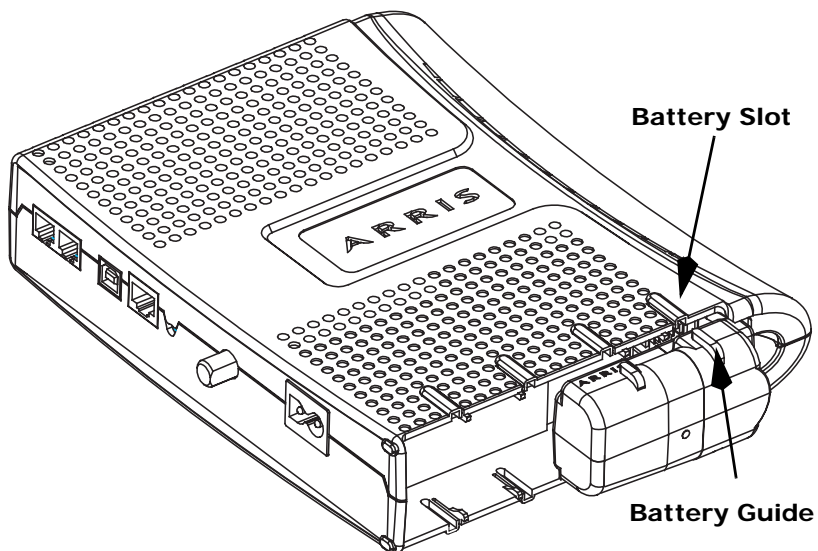

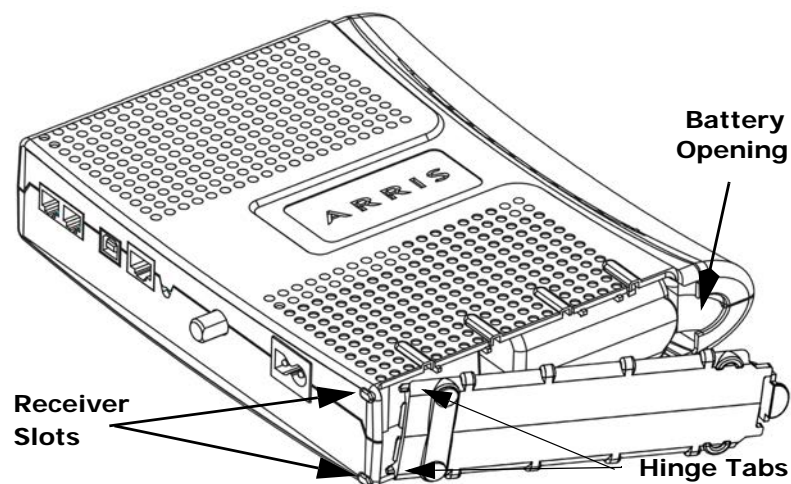

- 3 Push the battery pack into the bay until it seats into place. The following diagram shows a Telephony Modem with a 2-cell battery pack installed. **If you are taking the battery out of the unit, position your finger in the battery opening area and use leverage to dislodge the battery while pulling it straight back.**

Note: The Telephony Modem will not begin operating until you apply AC power.

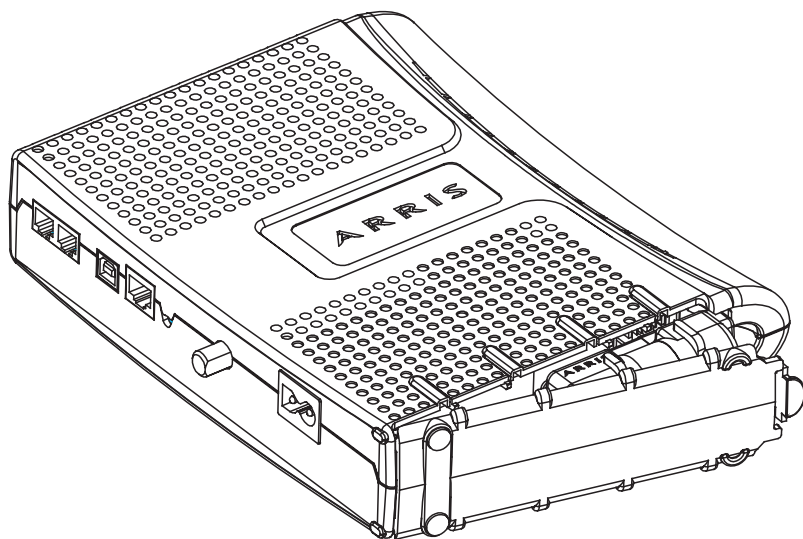

- 4 Replace the door. To do so, place the hinge tabs of the battery door into the receiver slots inside the Telephony Modem battery compartment on the opposite end of the battery opening slot. Rotate the door toward the unit until the latch snaps back into place.

Note: Some Telephony Modem models use a Lithium-Ion battery pack. Please recycle or dispose of the battery responsibly and in accordance with local ordinances.



TM602G/H 4-cell Battery Installation and Replacement

Use this procedure to install or replace a 4-cell backup battery.

Action

- 1 Insert a finger into the latch opening, press down and pull back on the latch holding the battery door (on the bottom of the Telephony Modem). Pull the door toward you. Set the door aside in a safe place.

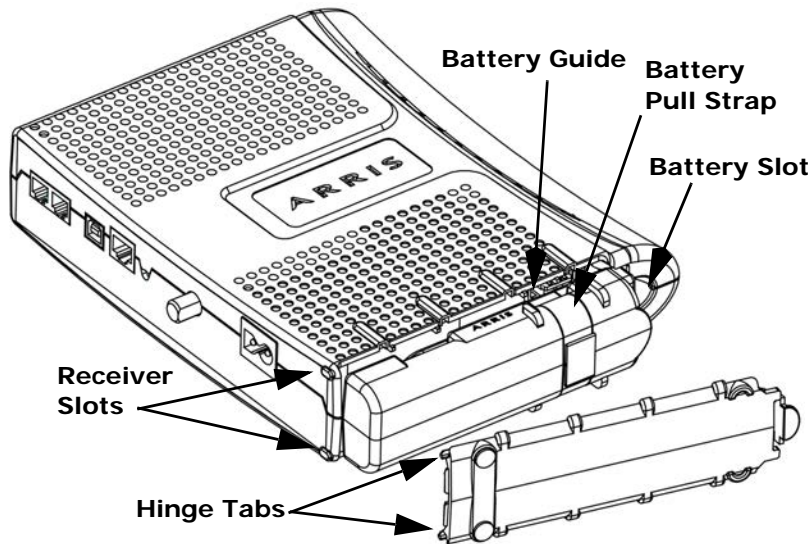
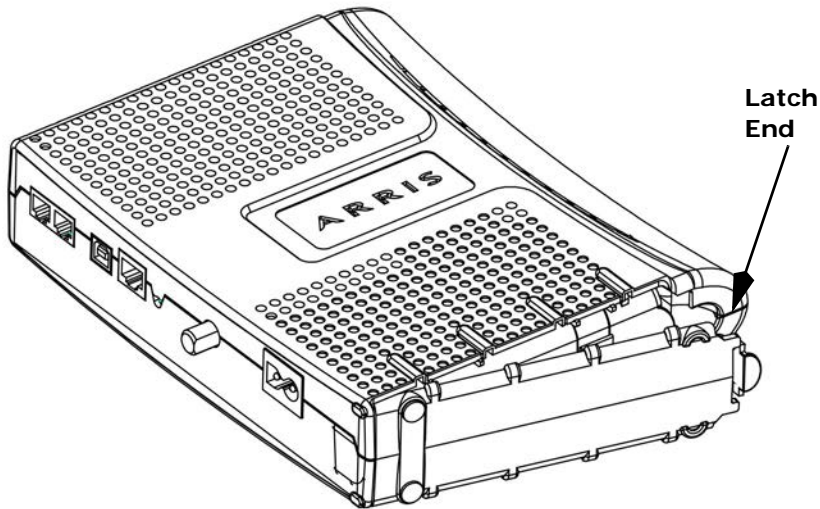

- 2 Hold the battery pack so that the guides on the battery align with the slots on the Telephony Modem and slide the battery into the bay. The diagram on the left shows the proper orientation.

Note: Batteries will not insert completely into the Telephony Modem if not oriented correctly. The battery should slide into the bay without significant force. Line up the slots in the battery bay with the guides on the battery and apply even pressure on both ends of the battery.

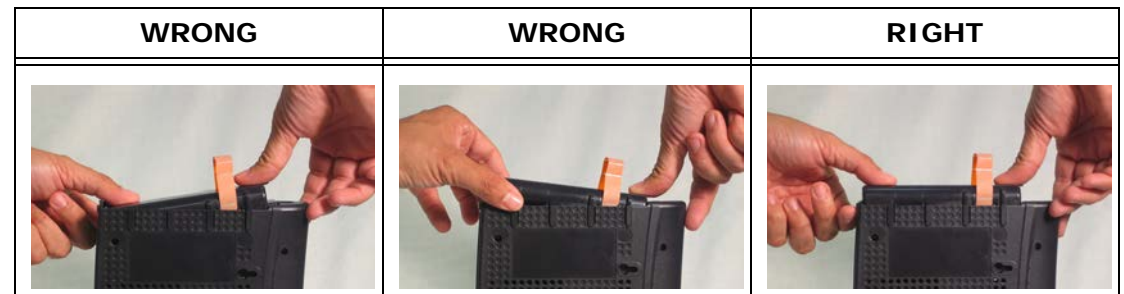

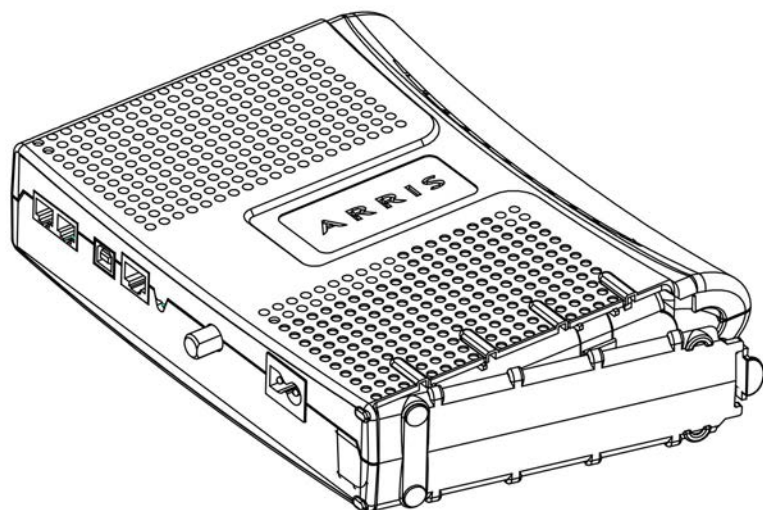
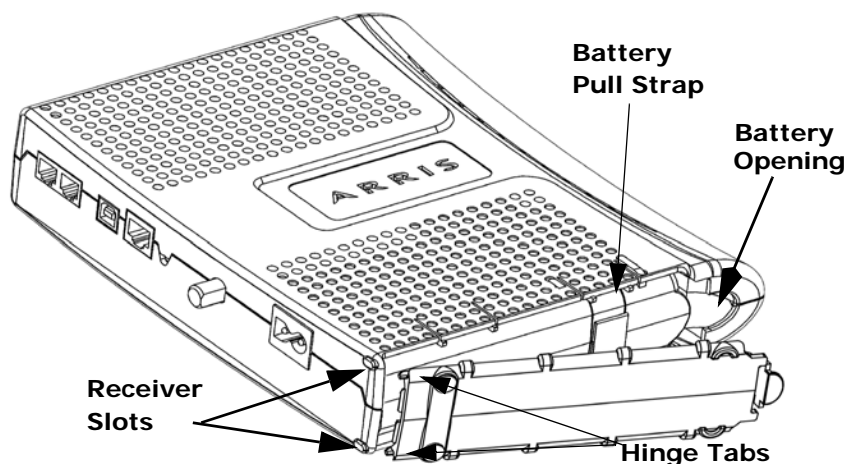

- 3 Push the battery pack into the bay until it latches into place. The following diagram shows a Telephony Modem with a 4-cell battery pack installed. **If you are taking the battery out of the Telephony Modem, use the battery pull strap to dislodge the battery.**

Note: The Telephony Modem will not begin operating until you apply AC power.

- 4 Replace the door. To do so, place the tabs of the battery door into the slot on the Telephony Modem battery compartment. Rotate the door toward the front of the Telephony Modem until the latch snaps back into place.

Note: Some Telephony Modem models use a Lithium-Ion battery pack. Please recycle or dispose of the battery responsibly and in accordance with local ordinances.



TM602G/H 8-cell Battery Installation and Replacement

The 8-cell lithium-ion battery pack is a separate option, compatible with the TM602G/H Telephony Modems, and provides extended hold-up times. Use this procedure to install and to replace the backup battery.

Action

- 1 If the Telephony Modem is wall-mounted, lift the Telephony Modem off the screws and place it on a firm horizontal surface for battery installation.
- 2 Insert a finger into the latch opening, press down and pull back on the latch holding the battery door (on the bottom of the Telephony Modem). Pull the door toward you.

Note: The 8-cell battery replaces the battery door. Store the door in a safe place.

- 3 If you are replacing an 8-cell battery, grasp the battery, pull back on the latch, and gently rock the battery out of the bay.
- 4 Place the new (or replacement) 8-cell battery on a firm horizontal surface.

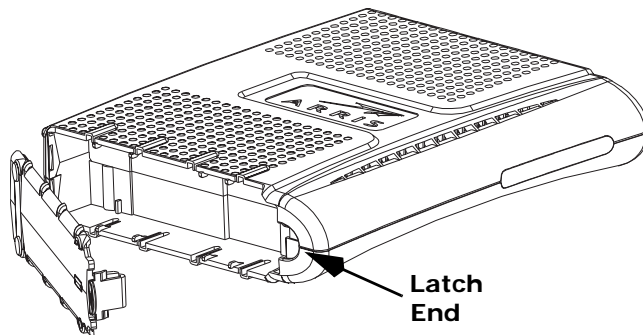

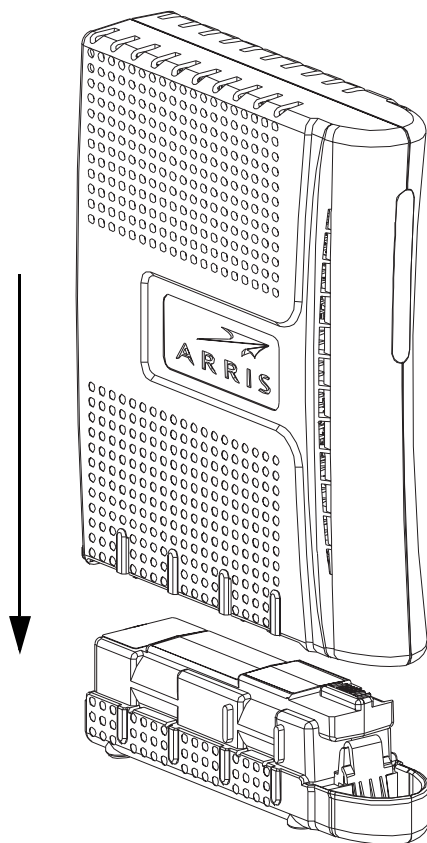

- 5 Position the Telephony Modem over the battery, making sure to line up the slots on the battery bay with the tabs on the battery. Push straight down on the Telephony Modem until the battery latch clicks into place.
Note: You may need to push down gently on the front of the Telephony Modem to latch the battery into place.
 - 6 If the Telephony Modem is wall-mounted, replace it on the mounting screws.
- Note:** When replacing a battery, please recycle or dispose of the battery responsibly and in accordance with local ordinances.

Installing and Connecting Your Telephony Modem

Before you start, make sure that:

- You have contacted your cable company and verified that they provide data and telephone service using standard DOCSIS technology.
- You have all the [Items You Need](#).
- Cable, phone, and power outlets are available near the computer. If a cable outlet is not conveniently located, your cable company can install a new one.

If you have ordered service, your cable company should configure the Telephony Modem automatically. You need only follow the instructions in this section to install and connect the Telephony Modem.



CAUTION

Risk of equipment damage

Only qualified installation technicians should connect the Telephony Modem to house wiring. Incumbent telephone service must be *physically* disconnected at the outside interface box before making any connections.



TM602A/B

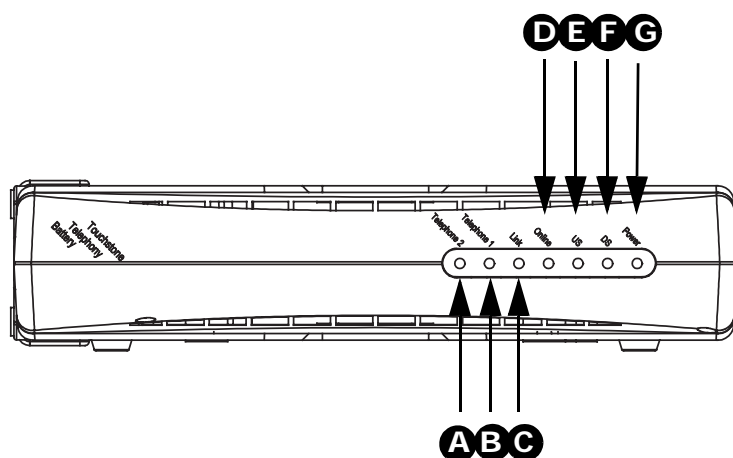

Front Panel TM602A/B

The front of the Telephony Modem has the following indicators:

- A Telephone 2:** indicates the status of line 2
- B Telephone 1:** indicates the status of line 1
- C Link:** indicates Ethernet (all models) or USB (A/B models only) connectivity between the Telephony Modem and computer
- D Online:** indicates internet data transmission status
- E US:** indicates upstream connectivity
- F DS:** indicates downstream connectivity
- G Power:** indicates whether AC power is available to the unit

TM602G/H

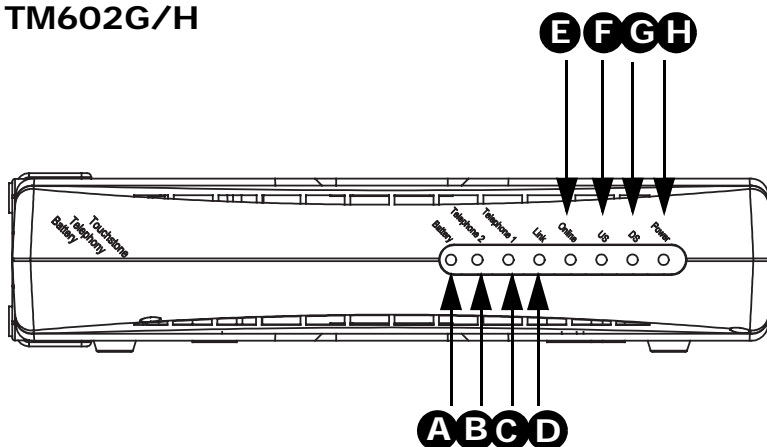

Front Panel TM602G/H

The front of the Telephony Modem has the following indicators:

- A Battery:** indicates status of the battery in the Telephony Modem
- B Telephone 2:** indicates status of line 2
- C Telephone 1:** indicates status of line 1
- D Link:** indicates Ethernet or USB connectivity between the Telephony Modem and computer
- E Online:** indicates internet data transmission status
- F US:** indicates upstream connectivity
- G DS:** indicates downstream connectivity
- H Power:** indicates whether AC power is available to the unit



Rear Panel

The rear of the Telephony Modem has the following connectors and controls:

TM602A/B Rear Panel

TM602A/B

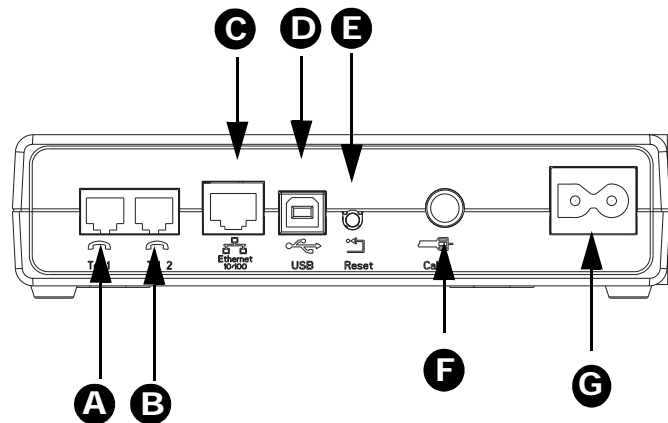

- A Tel 1: connector for the first phone line.
- B Tel 2: connector for the second phone line.
- C [Ethernet connector](#): for use with a computer or home network LAN connection.
- D [USB connector](#): for use with a computer USB connection.
- E Reset button: resets the Telephony Modem as if you power cycled the unit. Use a pointed **non-metallic** object to press this button.
- F Cable: connector for the [coax cable](#).
- G Power: connector for the power cord.

TM602G/H

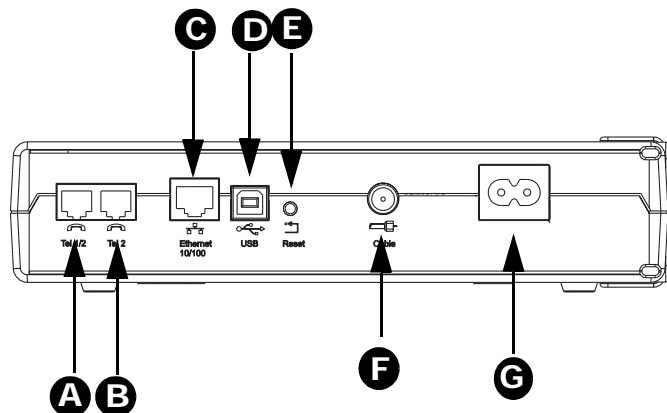

TM602G/H Rear Panel

- A Tel 1/2 (TM602G only): connector for the first phone line (or both lines of a 2-line phone).
- Tel 1 (TM602H only): connector for the first phone line.
- B Tel 2: connector for the second phone line.
- C [Ethernet connector](#): for use with a computer or home network LAN connection.
- D [USB connector](#): for use with a computer USB connection.
- E Reset button: resets the Telephony Modem as if you power cycled the unit. Use a pointed **non-metallic** object to press this button.
- F Cable: connector for the [coax cable](#).
- G Power: connector for the power cord.



Mounting the Telephony Modem

You can either mount the Telephony Modem on a wall or place it on a desktop. For wall-mount applications, you can mount the Telephony Modem with the indicators facing upward (vertical) or to the side (horizontal).

Note: If your Telephony Modem has an 8-cell battery installed, orient the Telephony Modem horizontally, with the battery side facing the floor.

Tools and Materials

For wall-mounted installations, make sure you have the following tools and materials before proceeding:

- for mounting on drywall: Two 1/4" (6mm) drywall anchors and a drill with 1/4" (6mm) bit (not included)
- for mounting on plywood or studs: two #6 x 1.5" (38.1 mm) self tapping screws (included)
- screwdriver (flat-blade or Phillips, depending on what kind of screws you use)
- wall-mount template (included with the Telephony Modem Quick Installation Guide)
- transparent tape (for temporarily securing the mounting template to the wall)

Location

Always position the Telephony Modem:

- within reach of an AC outlet. The power cord must reach the outlet without stretching and without adding extension cords.
- near a cable outlet (to avoid long cable runs).

Note: When mounting the Telephony Modem on drywall, try to position the Telephony Modem so at least one of the screws are fastened to a stud. This may prevent the Telephony Modem from pulling out of the wall in the future.

To prevent overheating of the Telephony Modem, do not block the ventilation holes on the sides of the unit.



Instructions

Wall-mounting instructions

- 1 Position the mounting template on the surface where you intend to mount the Telephony Modem and secure in place with transparent tape.
- 2 Drill holes through the template in the specified locations for the mounting screws. After drilling holes, remove the template from the surface.
- 3 If using drywall anchors, set them into the wall. Then, drive the screws into the wall leaving a gap of about 1/8" (3 mm) between the screw head and the wall. If not using anchors, just drive the screws.
- 4 Orient the Telephony Modem with the indicator lights facing up or right, as desired. Slip both mounting slots (in the back of the Telephony Modem) over the screws, then slide the case down until the narrow end of the keyhole slot contacts the screw shaft.
- 5 Proceed to [Connecting the Telephony Modem](#).

Desktop mounting instructions

- 1 Position the Telephony Modem so that:
 - air flows freely around it
 - the back faces the nearest wall
 - it will not fall to the floor if bumped or moved
- 2 Proceed to [Connecting the Telephony Modem](#).



Step 1



Step 2



Step 3



Step 4

TM602A/B

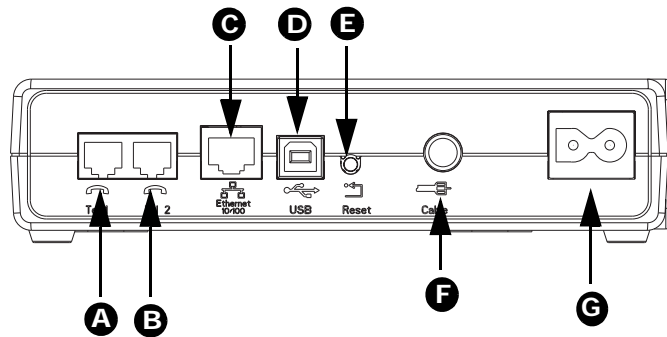

TM602G/H

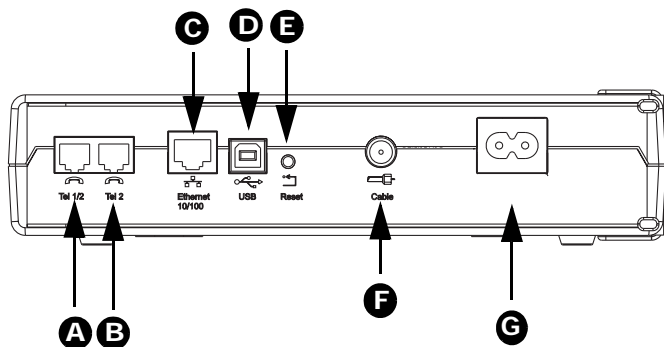

Connecting the Telephony Modem

WARNING: Connecting the Telephony Modem to the home's existing telephone wiring should only be performed by a professional installer. Physical connections to the previous telephone provider must be removed and the wiring must be checked; there must not be any voltage. Cancellation of telephone service is not adequate. Failure to do so may result in loss of service and/or permanent damage to the Telephony Modem.

- 1 Connect one end of the coax cable to the cable outlet or splitter, and the other end to the Telephony Modem's Cable connector (F). Tighten the connections by hand, then tighten an additional 1/8 turn with a wrench.

Note: For best performance, use high-quality RG-6 coax cable and minimize or eliminate splitters between the cable jack and the Telephony Modem.

- 2 Insert the plug from the power cord into the Power connector on the Telephony Modem (G) and insert the power cord into a convenient AC outlet.

The Power light on the front of the Telephony Modem lights up, then flashes once (refer to the LED table on page 44). See [Troubleshooting](#) if the Power light does not turn on.

- 3 After connecting the coax cable and power, proceed as needed:

- [Making Ethernet Connections](#) OR
- [Making USB Connections](#)

Note: Do not connect the same computer to both the Ethernet and USB ports.

Making Ethernet Connections

- 4 Connect one end of the Ethernet cable to the port on the back of the Telephony Modem labeled "Ethernet 10/100," (C) and the other end to the Ethernet port on a computer, hub, or broadband router.

Note: If you are connecting to a computer, use the Ethernet cable included in the Telephony Modem package.



Making USB Connections

- 5 Connect one end of the USB cable to the USB port on the computer, and the other end to the USB port on the back of the Telephony Modem (**D**).

Your computer should detect the Telephony Modem and begin installing the drivers. See [Installing USB Drivers on Your PC](#) for driver installation details.

Making Telephone Connections

- 6 Connect one end of the telephone cable to the telephone port on the back of the Telephony Modem (**A** or **B**). Connect the other end to the telephone.

Note: If you have a TM602G Telephony Modem and a phone with two separate lines on a single RJ-14 cord, it must be plugged into the port labeled "Tel 1/2".



Installing USB Drivers on Your PC

When you plug the Telephony Modem into the PC's USB port, Windows automatically detects the hardware and begins installing the USB drivers.

This procedure does not explain how to provision the Telephony Modem or otherwise initiate actual service.

The latest USB drivers and documentation are available on line at <http://www.arrisi.com/support/usb/index.asp>

Requirements

Make sure you have the following before attempting to install the USB drivers:

- PC with:
 - CD-ROM drive
 - at least one free USB port
 - one of: Windows 2000, Windows XP, or Windows Vista (Windows 95, Windows 98, and Windows NT are **not** supported)
 - ARRIS USB Driver CD
- USB [A/B Cable](#) of appropriate length (a cable is included in your Telephony Modem package)
- (for installations not using DHCP) IP address, subnet, gateway, and DNS information

Installation Instructions

Select the link for your operating system to see the installation instructions.

- [Installing USB Drivers on Windows 2000](#)
- [Installing USB Drivers on Windows XP](#)
- [Installing USB Drivers on Windows Vista](#)



Installing USB Drivers on Windows 2000

Follow these steps to install USB drivers on Windows 2000.

- 1 Make sure the Telephony Modem is on (the **Power** light should be on). If not, connect the AC adapter as described in [Connecting the Telephony Modem](#).
- 2 Insert the CD that came with the Telephony Modem package into the CD-ROM drive.
- 3 Plug the appropriate end of the USB cable into the Telephony Modem and the other end into the computer's USB port.

The following window appears, indicating that the PC has detected a new USB device:

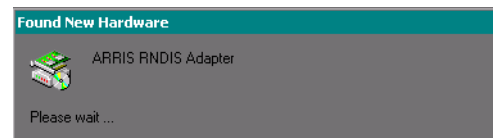

- 4 Wait for the system to start the installation wizard and display the following window (there may be a short delay):



5 Click the **Next** button.

The wizard prompts you for the location of the drivers.

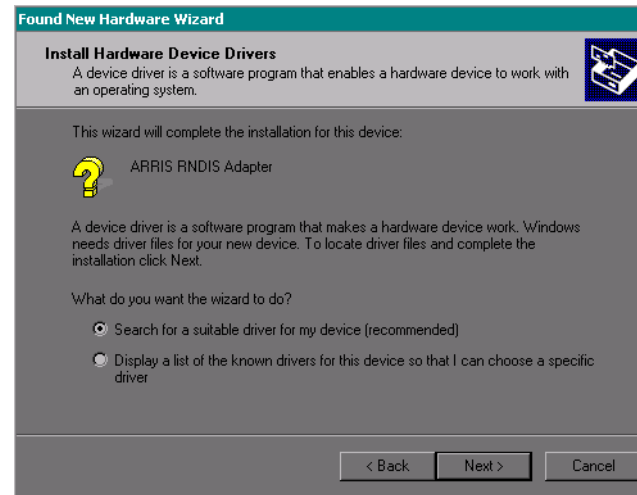

Note: The dialog indicates that the wizard is looking for the ARRIS RNDIS (Remote Network Device Interface Specification) driver for the Telephony Modem.



- 6 Select "Search for a suitable driver for my device", unless you want to use the second option to choose a specific driver, then click the **Next** button.

The wizard displays a list of search options.

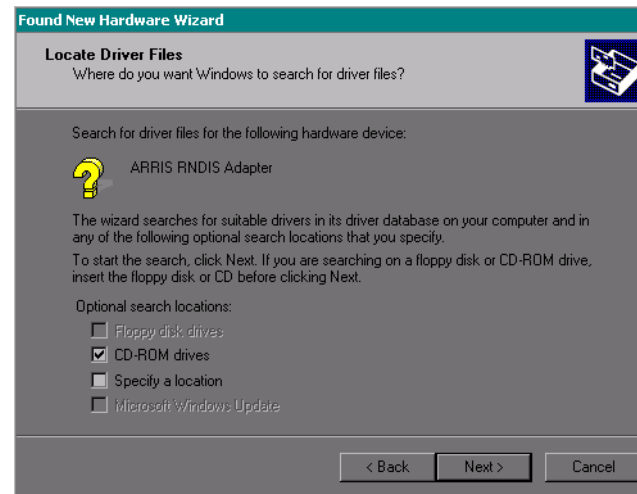

- 7 Make sure the **CD-ROM** option is selected (checked), then click the **Next** button.

The wizard searches the specified locations, then displays the location and name of the appropriate driver.

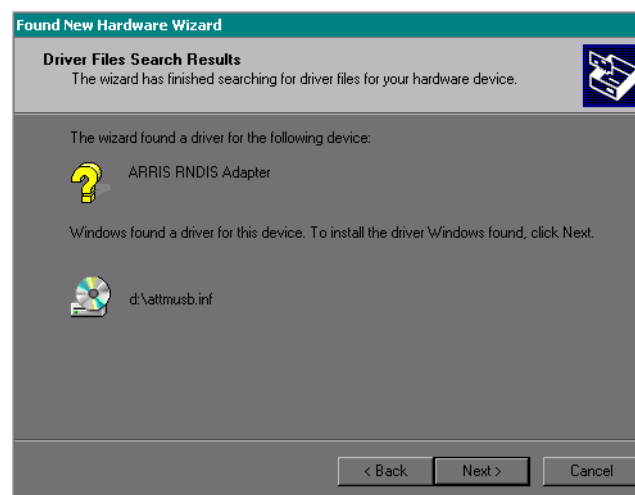

Note: If the wizard can not find the CD drive, and the CD is inserted properly, follow these steps:

- a. On the Windows desktop, open "My Computer" and note the letter of the Compact Disc (or CD-ROM) drive (on most systems, the CD drive is at D: or E:)
- b. Return to the Found New Hardware Wizard, and click the **Back** button.
The wizard displays the previous screen, shown in step 6.
- c. Select "Specify a Location," then choose the drive letter that corresponds to the CD drive from the menu.
- d. Click the Next button.

You should now see the screen shown above. If not, contact your cable company for help.



- 8 Click the **Next** button.

The wizard installs the drivers, then displays a window indicating that the installation is complete.

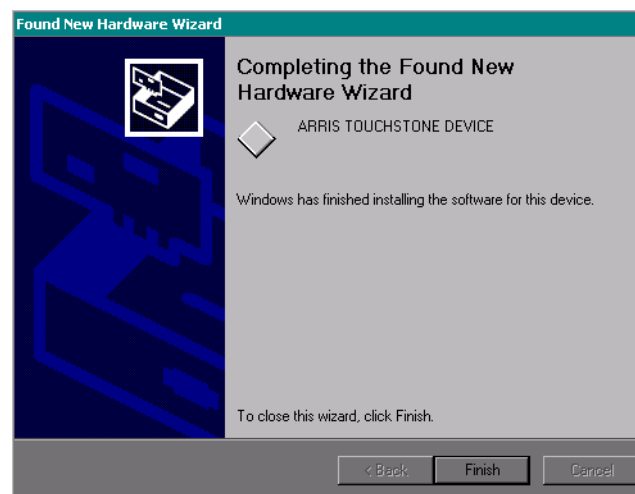

- 9 Click the **Finish** button.



Installing USB Drivers on Windows XP

Follow these steps to install USB drivers on Windows XP.

- 1 Make sure the Telephony Modem is on (the **Power** light should be on). If not, connect the AC adapter as described in [Connecting the Telephony Modem](#).
- 2 Insert the CD that came with the Telephony Modem package into the CD-ROM drive.
- 3 Plug the appropriate end of the USB cable into the Telephony Modem and the other end into the computer's USB port.

The following window appears, indicating that the PC has detected a new USB device:



- 4 Click the **Next** button.

The wizard begins searching for and installing the drivers, then displays a window indicating that the installation is complete.



- 5 Click the **Finish** button.



Installing USB Drivers on Windows Vista

Follow these steps to install USB drivers on Windows Vista.

Installing Touchstone USB Drivers on Vista in 32-bit Mode

When running Vista in 32-bit mode, simply connect your PC to the Touchstone Telephony Modem or Cable Modem. The Vista Hardware Installation Wizard finds the correct 32-bit USB driver and installs it for you.

Installing Touchstone USB Drivers on Vista in 64-bit Mode

When running Vista in 64-bit mode, you must install an updated Vista USB 1.1 driver. Follow these steps to obtain and install the driver.

- 1 Download the zipped Vista USB driver from the ARRIS website at the following link:
<http://www.arrisi.com/support/usb/index.asp>
- 2 Unzip the files to a directory that can be referenced later (Step 8) during the installation of the USB driver.
- 3 Connect the USB cable between the Touchstone Cable Modem or Telephony Modem and personal computer running Vista.
- 4 When the Found New Hardware screen is presented, select the “Locate and install driver software (recommended)” option.



- 5 When you see a window with the heading “Windows needs your permission to continue,” click **Continue** to proceed.



- 6 Vista tries to locate the new USB driver, and displays a “Installing device driver software” at the bottom right of the screen. Vista will *not* find the driver, and displays the following window. At the prompt, select **I don't have the disc. Show me other options.**

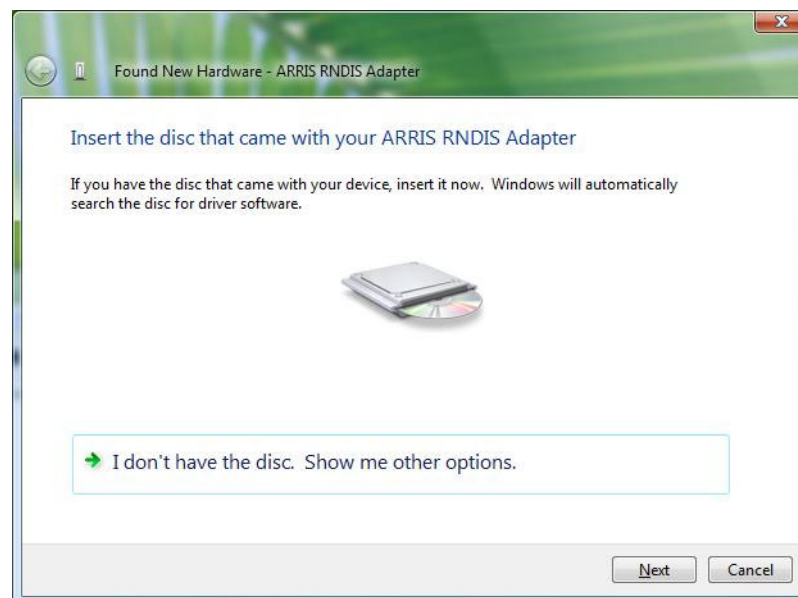

7 Select **Browse my computer for driver software (advanced)**.

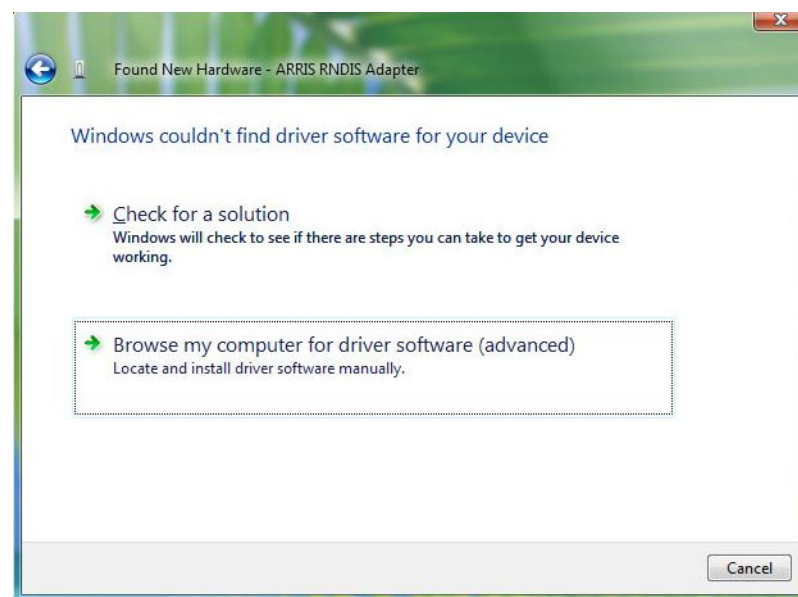

- 8 Browse to the directory that you set up in step 2. Select **Next**.

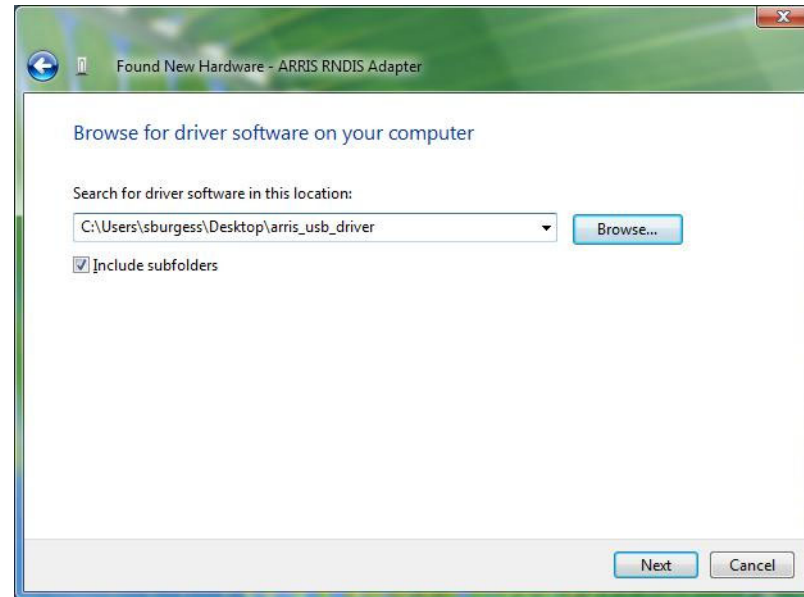

- 9 Once Vista finds the driver software in the directory specified in step 8, installation is in progress as shown below.

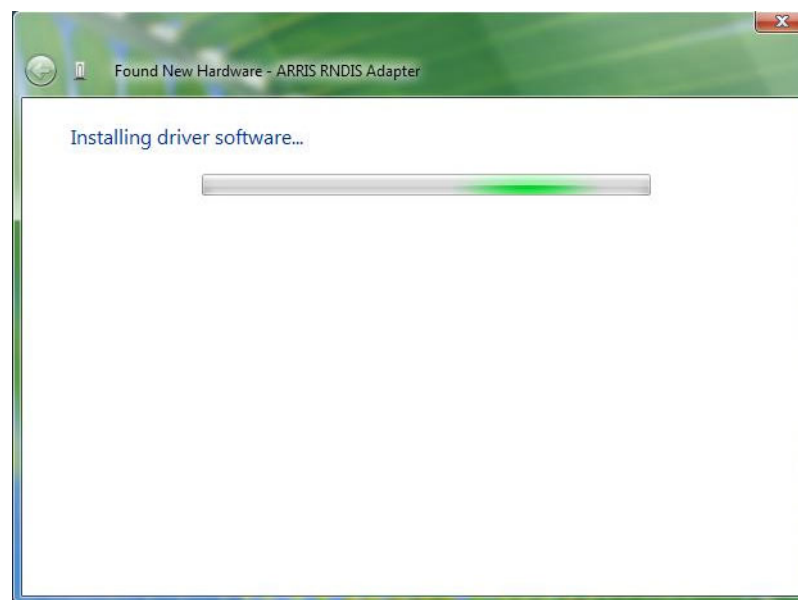

- 10 The Found New Hardware wizard should display the following screen when the USB driver has been successfully installed. Select **Close**.

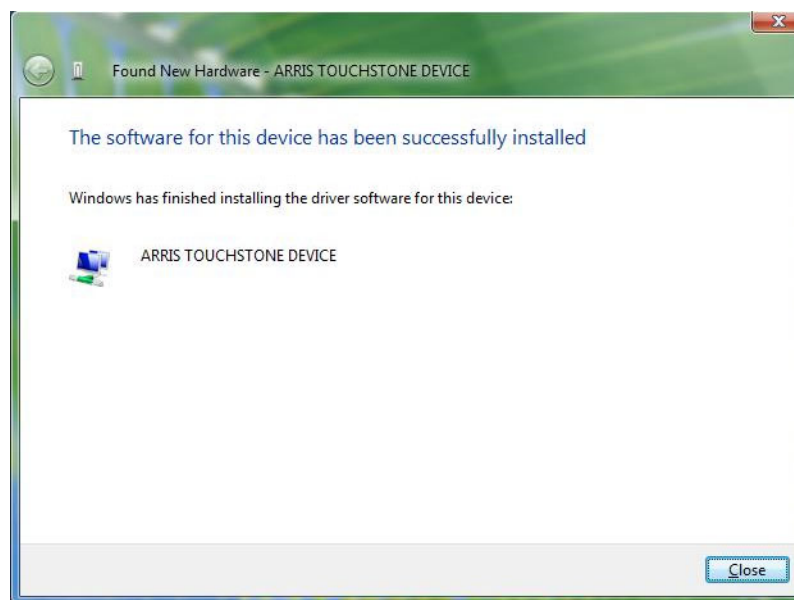

- 11 Once the installation is completed successfully, Vista displays an icon with the message "ARRIS TOUCHSTONE DEVICE, Device driver software installed successfully" at the bottom right corner of the screen.



Removing USB Drivers

You use a Remove utility to remove ARRIS USB drivers. The 64-bit version of Vista uses a special utility; other versions of Windows use a single utility.

Removing USB Drivers (all but 64-bit Vista)

If you connect the Telephony Modem USB to your computer before inserting the ARRIS driver installation CD, Windows may install a “composite” USB driver that does not properly support the Telephony Modem. To correct this problem, you must first remove the composite driver using the Remove utility on the ARRIS driver installation CD. Follow these steps to use the Remove utility:

- 1 Insert the ARRIS driver installation CD.
- 2 Navigate to the CD drive:

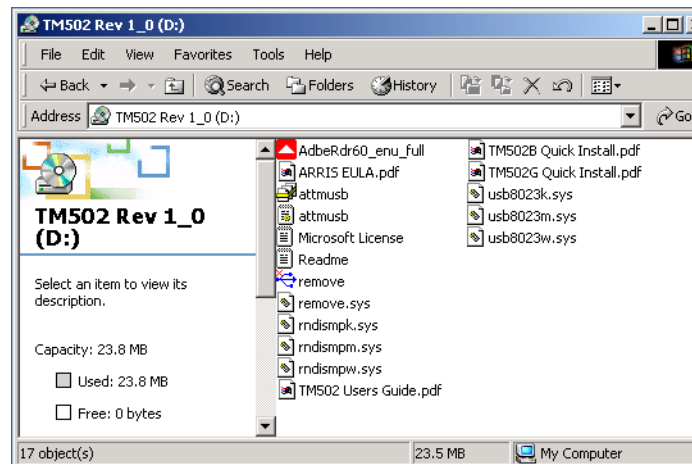

- 3 Start the Remove utility by double-clicking it in the window.

The Remove utility prompts you to click OK to remove the USB driver, or Cancel to quit.



- Click the OK button.

The Remove utility displays the following message:

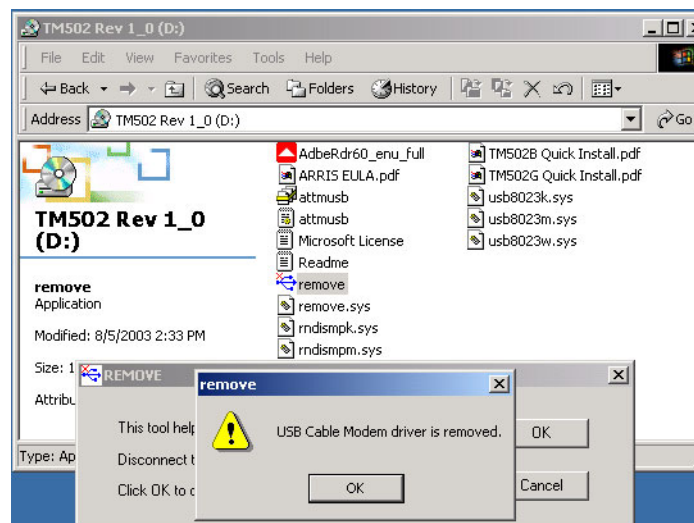

- Leave the CD in the drive, reconnect the Telephony Modem, and install the USB driver as appropriate for your operating system.

Removing USB Drivers (64-bit Vista)

Follow these steps to uninstall the 64-bit USB driver, if necessary.

- If you no longer have the USB driver, download the zipped Vista USB driver from the ARRIS website at the following link:
<http://www.arrisi.com/support/usb/index.asp>
- If necessary, unzip the files to a directory that can be accessed for the un-installation.
- Connect the USB cable between the Touchstone Cable Modem or Telephony Modem and personal computer running Vista.
- Open the directory created in step 2 (or during the original driver installation, if you kept it).
- Locate the file `remove.exe`.



- 6 Right-click on the `remove.exe` file, and select **Run as administrator** from the drop-down menu. Enter the administrator password, if prompted.
- 7 Follow the instructions as prompted to remove the driver.



Configuring Your Ethernet Connection

If your computer is equipped with a LAN card providing an Ethernet connection, you may have to configure your computer's TCP/IP settings. The steps that follow will guide you through setting your computer's TCP/IP settings to work with the Telephony Modem.

Requirements

Make sure you have the following before attempting to configure your Ethernet connection:

- Computer with:
 - one of: Windows 98SE, Windows 2000, Windows ME, Windows XP, or Windows Vista
 - Ethernet interface
- Ethernet cable (supplied)
- IP address, subnet, gateway, and DNS information for installations not using DHCP

How to use this chapter

The following list shows the procedures for modifying the TCP/IP settings on the computer. The procedure is slightly different depending on the operating system that you are using. Please ensure you are using the correct steps for the operating system on your computer. Follow the links below for instructions to configure your ethernet connection on your operating system.

- [TCP/IP Configuration for Windows 98SE](#)
- [TCP/IP Configuration for Windows 2000](#)
- [TCP/IP Configuration for Windows ME](#)
- [TCP/IP Configuration for Windows XP](#)
- [TCP/IP Configuration for Windows Vista](#)



TCP/IP Configuration for Windows 98SE

Follow these steps to configure the TCP/IP settings on a Windows 98SE operating system.

Note: Dialog boxes shown on your computer may differ slightly from those shown in this procedure.

- 1 From the computer, select **Start > Settings > Control Panel**.
- 2 Double click on the **Network** icon in the Control Panel.



- 3 Click the **Configuration** tab in the Network window to display the list of Network Adapters.



- 4 Highlight **TCP/IP** by clicking on it one time, then click on **Properties**.

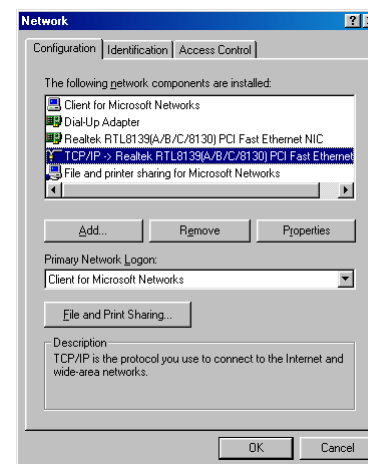

- 5 Click the **IP Address** tab, click **Obtain an IP address automatically**, then click **OK**.

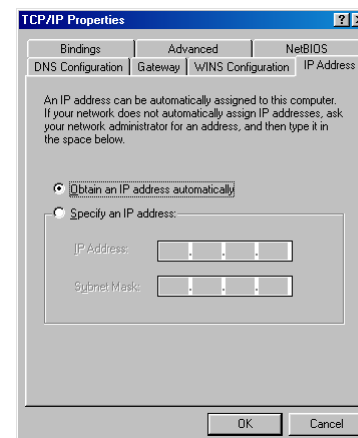

- 6 Click **OK** to accept the new settings, and **OK** again to close the Configuration window.
- 7 You may have to restart your computer in order for your computer to obtain a new IP address from the network.

—end—



TCP/IP Configuration for Windows 2000

Follow these steps to configure the TCP/IP settings on a Windows 2000 operating system.

Note: Dialog boxes shown on your computer may differ slightly from those shown in this procedure.

- 1 From the computer, select **Start > Settings > Network and Dial-up Connections > Local Area Connection**.
- 2 In the Local Area Connections Properties window, highlight **TCP/IP** by clicking on it one time, then click on **Properties**.

Note: If your computer has more than one Ethernet card, you may have to select the appropriate Ethernet card in the **Connect using:** area of the Local Area Connection Properties window.

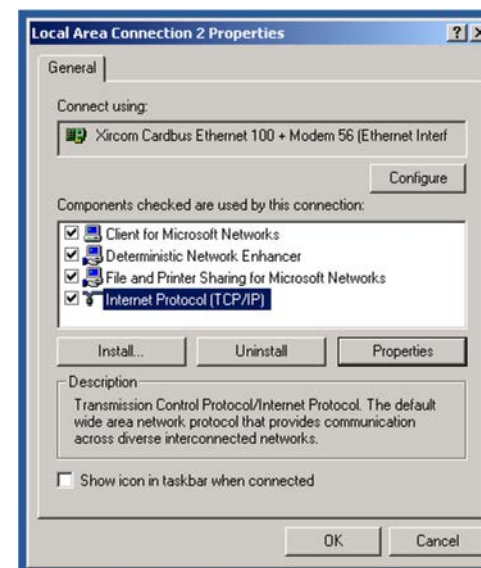

- 3 Click **Obtain an IP address automatically** and **Obtain DNS server address automatically**, then click **OK**.

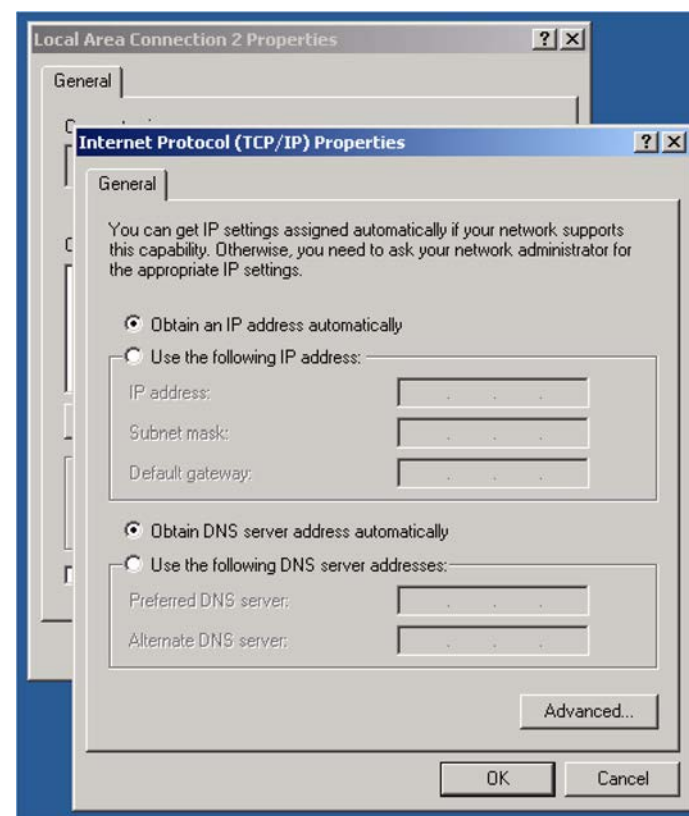

- 4 Click **OK** to accept the new settings, and **OK** again to close the Configuration window.
- 5 You may have to restart your computer in order for your computer to obtain a new IP address from the network.

—end—



TCP/IP Configuration for Windows ME

Follow these steps to configure the TCP/IP settings on a Windows ME operating system.

Note: Dialog boxes shown on your computer may differ slightly from those shown in this procedure.

- 1 From the computer, select **Start > Settings > Control Panel**.
- 2 Double click on the **Network** icon in the Control Panel.

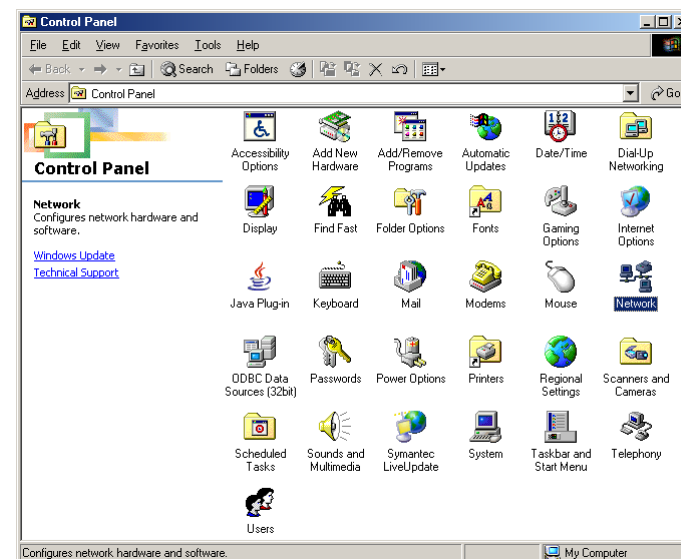

- 3 Click the **Configuration** tab in the Network window to display the list of Network Adapters.



- 4 Highlight **TCP/IP** by clicking on it one time, then click on **Properties**.

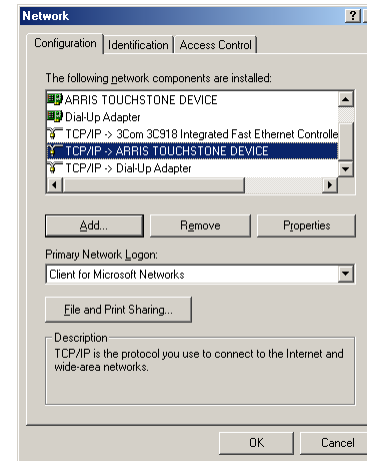

- 5 Click the **IP Address** tab, then click **OK**.

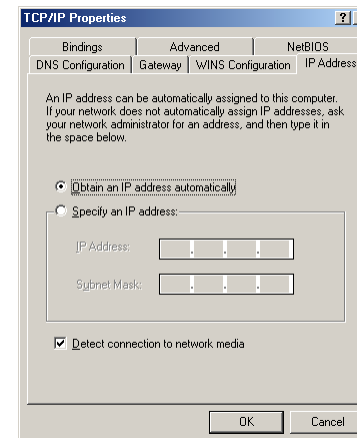

- 6 Click **OK** to accept the new settings, and **OK** again to close the Configuration window.
- 7 You may have to restart your computer in order for your computer to obtain a new IP address from the network.

—end—



TCP/IP Configuration for Windows XP

Follow these steps to configure the TCP/IP settings on a Windows XP operating system.

Note: Dialog boxes shown on your computer may differ slightly from those shown in this procedure.

- 1 From the computer, select **Start > Settings > Control Panel** and double click on the **Network Connections** icon in the Control Panel.
- 2 Click the **Configuration** tab in the Network window to display the list of Network Adapters.

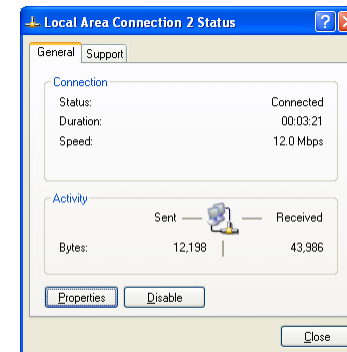

- 3 Highlight **TCP/IP** by clicking on it one time, then click on **Properties**.

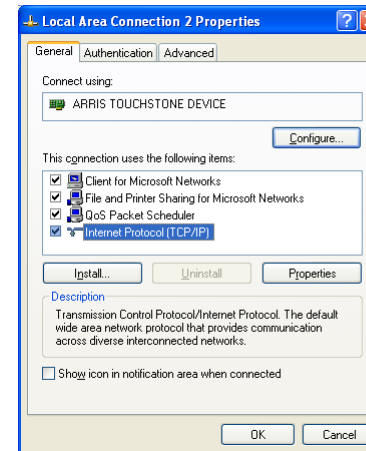

- 4 Click the **IP Address** tab, click **Obtain an IP address automatically**, then click **OK**.

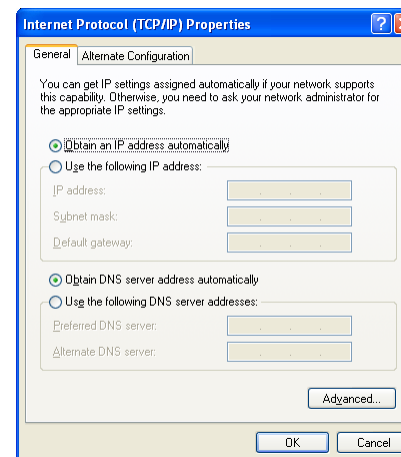

- 5 Click **OK** to accept the new settings, and **OK** again to close the Configuration window.
- 6 You may have to restart your computer in order for your computer to obtain a new IP address from the network.



TCP/IP Configuration for Windows Vista

Follow these steps to configure the Ethernet interface for use with Touchstone products.

- 1 Open the Vista Control Panel.

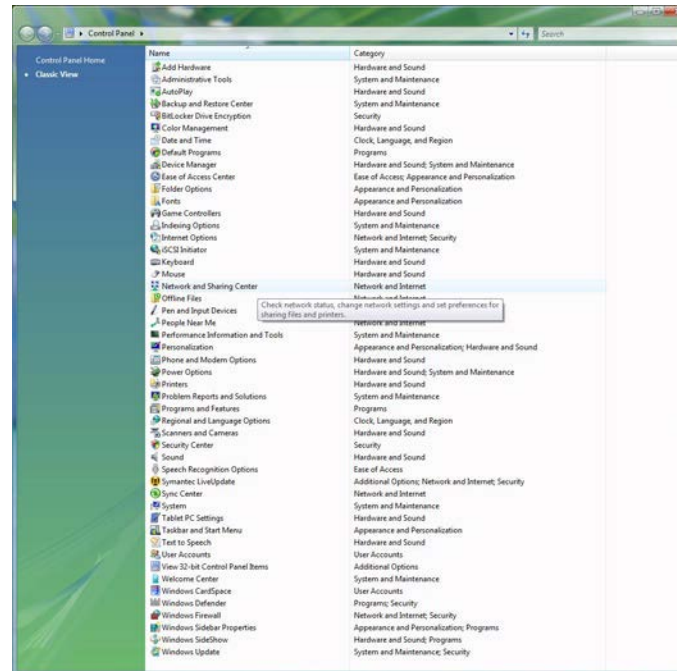

2 Double-click **Network and Sharing Center**.

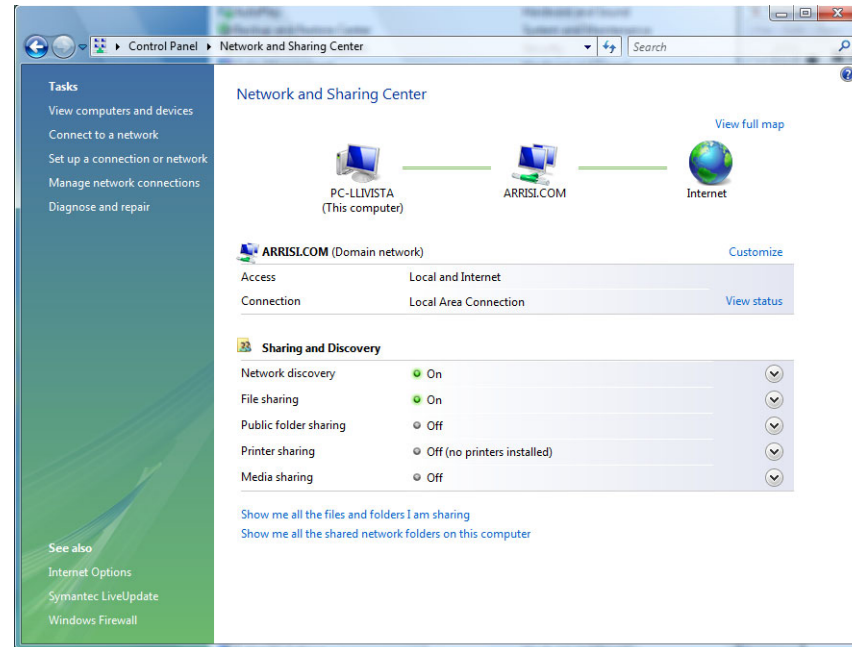

- 3 Click **Manage network connections**. If prompted for a connection, choose **Local Area Connection**.

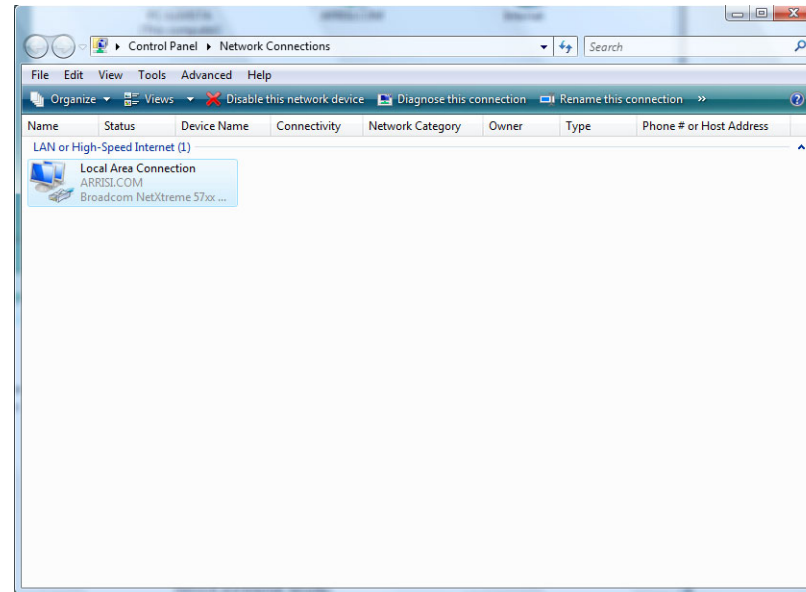

- 4 Double-click the **Local Area Connection** to open the Status window:

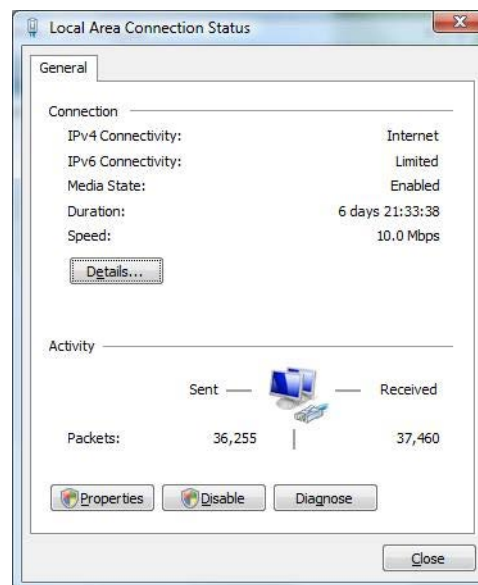

- 5 If Windows requests permission to continue, click **Continue**.
- 6 Click **Properties**.

7 Double-click **Internet Protocol Version 4 (TCP/IPv4)**.

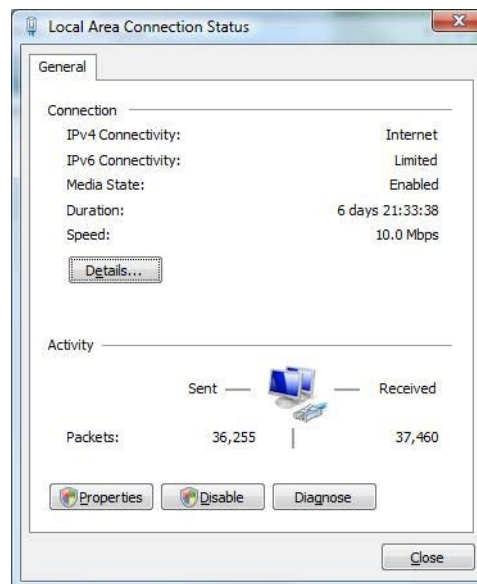

- 8 Select **Obtain an IP address automatically** and **Obtain DNS server address automatically**, unless instructed otherwise by your cable provider.
- 9 Click **OK** to close the Properties windows.

Using the Telephony Modem

This chapter describes the controls and features available on the Touchstone Telephony Modem, and covers basic troubleshooting procedures.

- [Setting up Your Computer to Use the Telephony Modem](#)
- [Indicator Lights for the TM602A/B Models](#)
- [Indicator Lights for the TM602G/H Models](#)
- [Using the Reset Button](#)

Setting up Your Computer to Use the Telephony Modem

Follow the instructions in the information packet supplied by your cable company. Contact your cable company if you need help setting up your computer.



Indicator Lights for the TM602A/B Models

The Touchstone Telephony Modem has seven LEDs to assist in troubleshooting.

Wiring Problems

If the Telephony Modem begins flashing all its lights for more than 10 seconds, this indicates a problem with the telephone wiring — the red and green wires may be shorted (touching), or there may be undesired voltage on the lines. If this pattern persists for more than 10 seconds, disconnect the telephone lines from the Telephony Modem, then call a wiring technician for assistance.

Patterns: Normal Operation

The following table shows light patterns during normal operation.

Mode	Power	DS	US	Online	Link	Tel. 1/Tel. 2
AC Power	On	On = Connected to the Internet Flash = Not connected to the Internet	On = Connected to the Internet Flash = Not connected to the Internet	On = Internet Available Off = Internet not available	On = Computer Connected Off = Computer not connected Flash = Computer Activity	On = On-hook Flash = Off-hook Off = disabled
No AC Power	Off	Off	Off	Off	Off	Off
Firmware Upgrade	On	Flash	Flash	On	(normal operation)	(normal operation)

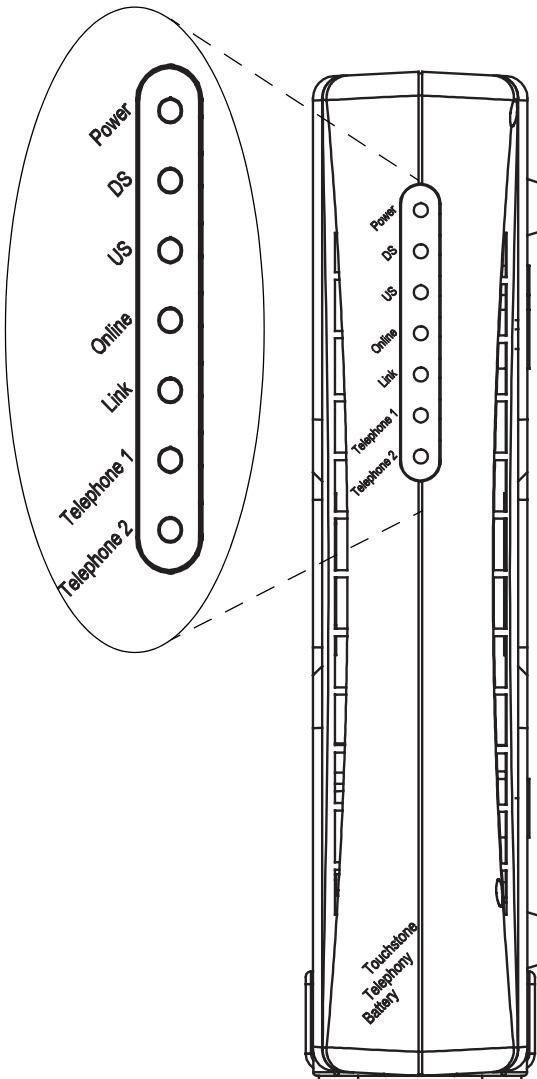

Indicator Lights for the TM602G/H Models

The Touchstone Telephony Modem has eight indicator lights to assist in troubleshooting. Note that not all models have a Battery light.

Battery Mismatch

If the Telephony Modem alternates flashing the Battery light and all other lights, the installed battery is incompatible with the Telephony Modem. Remove the battery and install one of the batteries described in [Battery Installation and Replacement \(TM602G/H Models Only\)](#).

Wiring Problems

If the Telephony Modem begins flashing all its lights for more than 10 seconds, this indicates a problem with the telephone wiring — the red and green wires may be shorted (touching), or there may be undesired voltage on the lines. If this pattern persists for more than 10 seconds, disconnect the telephone lines from the Telephony Modem, then call a wiring technician for assistance.

Indicator Lights: Normal Operation

The following table shows light patterns during normal operation.

Mode	Power	DS	US	Online	Link	Tel. 1/Tel. 2	Battery
AC Power Good	On	On = Connected to the Internet Flash = Not connected to the Internet	On = Connected to the Internet Flash = Not connected to the Internet	On = Internet Available Off = Internet not available	On = Computer Connected Off = Computer not connected Flash = Computer Activity	On = On-hook Flash = Off-hook Off = disabled	On = Battery good or low Off = Battery missing or MTA not registered Flash = Battery bad
No AC Power Battery Installed	Flash	Off	Off	Off	Off	On = On-hook Flash = Off-hook Off = disabled	Off = Battery power Flash = Battery bad or low
No AC Power No Battery	Off	Off	Off	Off	Off	Off	Off
Firmware Upgrade	On	Flash	Flash	On	(normal operation)	(normal operation)	(normal operation)

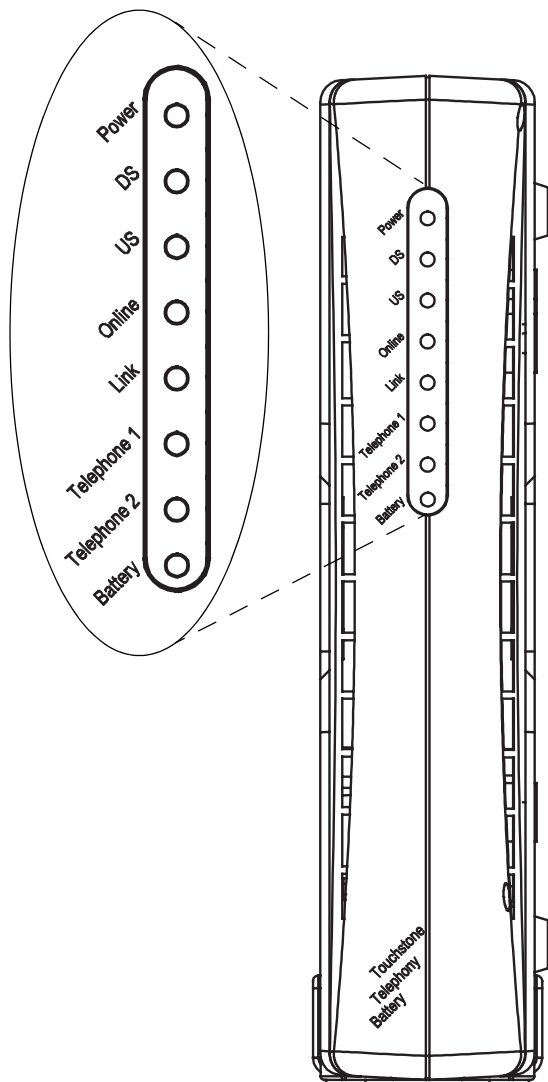

Indicator Lights: Startup Sequence

The following table shows the Telephony Modem light patterns during each phase of the startup sequence. There are two phases of startup; the Telephony phase and the cable modem phase. Both are outlined below.

Power, DS, US, Online	Link	Telephone		Battery*	Description
		1	2		
Off	Off	Off	Off	Off	No power to Cable Modem
Flash	Flash	Flash	Flash	Flash	Power-on Self Test
See "Cable Modem Start Up Sequence" Below					
On	On	Flash	Off	Off	Retrieving telephone network information
On	On	Off	Flash	Off	Retrieving telephone line information
On	On	Flash	Flash	Off	Activating telephone service
Normal Operation * = Battery LEDs only apply to those models with battery backup					

Cable Modem Start Up Sequence

DS	US	Online	Link	Description
Flash	Off	Off	Off	Downstream search
On	Flash	Off	Off	Downstream found; upstream search
On	On	Flash	Off	Downstream and Upstream found; retrieving setup information from cable operator



TM602A/B

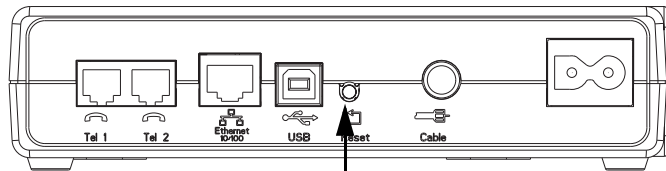

Reset Button

TM602G/H

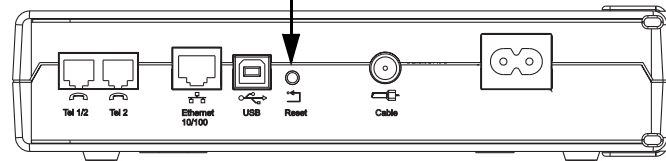

Using the Reset Button

Use the **Reset** button, on the back of the Telephony Modem, to reset the modem as if you power cycled the unit. You may need to reset the Telephony Modem if you are having problems connecting to the Internet. Using this button will be rare.

Use a pointed **non-metallic** object to press this button. The photo to the left shows the location of the **Reset** button.

The **Reset** button is recessed to prevent accidental resets.



Troubleshooting

Problems and Solutions

The Telephony modem is plugged in, but the Power light is off.

Check all power connections. Is the power cord plugged in firmly at both ends?

If you plugged the power cord into a power strip, make sure the strip is switched on.

Avoid using an outlet controlled by a wall switch, if possible.

Check the outlet by plugging in another device (such as a lamp).

Finally, check the fuse or circuit breaker panel.

I'm not getting on the Internet.

It may take over 30 minutes to establish a connection the first time you power up your Telephony Modem, especially when many people are online. Always leave your Telephony Modem plugged into AC power and connected to the cable system.

Check the front panel lights:

- The **Power** and **Online** lights should be on.
- The **Link** light should be either on or blinking.
- If the **Power** light blinks for more than 30 minutes, call your cable company for assistance.

Check your cable connections. Connectors should be finger-tight. The [coax cable](#) should not be pinched, kinked, or bent sharply—any of these can cause a break or short in the cable (you may have to replace the cable). If you have one or more splitters between the Telephony Modem and CATV outlet, remove the splitters and connect the Telephony Modem directly to the outlet.

Proceed to the Ethernet or USB solutions (next page) if necessary.



I'm not getting on the Internet. (Ethernet)

If you are using a hub, is the hub turned on?

Are you using the right type of [Ethernet cable](#)? Use the supplied cable for direct connection to a computer; use a cross-over cable for connection to a hub or home router.

Press the **Reset** button on the back of the Telephony Modem.

I'm not getting on the Internet. (USB)

Did you [load the USB drivers](#)?

If you are using a powered USB [hub](#), is the hub turned on?

Check the USB cable connections. Disconnect and reconnect the USB cable.

Restart the computer.

Press the **Reset** button on the back of the Telephony Modem.

I can get on the Internet, but everything is slow.

If the Web site you are visiting is very popular, that site may be having trouble servicing all the requests. If other sites download quickly, wait for a few minutes and try again. Usage during peak hours may also affect the connection speed.

If your Telephony Modem is connected to a LAN (Local Area Network), either directly or through a firewall, other communications on the LAN may slow down your connection.

To test your network speed, try an online test such as http://reviews.cnet.com/Bandwidth_meter/7004-7254_7-0.html

I have two computers connected to the Telephony Modem, but only one can get on the Internet.

Check your cable company's terms of service: they may allow only one computer to connect directly to the Telephony Modem.



I don't have dial tone when I pick up my phone, why?

In order for telephone service to be functional on the Telephony Modem, telephone service must have been purchased from the service provider and configured on your Telephony Modem. The following steps should help in identifying the source of the problem.

- Is the Power LED lit?
 - If not, check to make sure the Telephony Modem is plugged in and the outlet has power.
 - If the LED is lit, go to the next step.
- Is the Online LED lit?
 - If not, check the coax connection at the Telephony Modem and the wall. Ensure they are connected and tight. If they are and you do not have dial tone, contact your service provider.
 - If the Online LED is lit, go to the next step.
- Is the Telephone (Telephone 1 or Telephone 2) LED lit?
 - If not, phone service has not been provisioned on that line. Contact your service provider.
 - If it is blinking, there is a phone off hook somewhere in the house. Find that phone and hang it up.
 - If it is lit, go to the next step
- Is the Phone plugged directly into the Telephony Modem?
 - Make sure the phone is plugged into the port on the back of the Telephony Modem labeled "Tel 1/2" (TM602G) or "Tel 1" (TM602A/B/H) for line 1, and "Tel 2" for line 2.
 - If so, try a different phone. Make sure the new phone is a working phone.
 - If a known good phone is used and you still don't have dial tone, try a different phone cable. If a new phone and cable do not restore dial tone, call your service provider.
- Is the Telephony Modem plugged into a wall outlet?



- If so, unplug the RJ-11 connector at the back of the Telephony Port and plug in a known working phone. If you now have dial tone, the problem is with the house wiring. Contact your MSO or a qualified wiring technician to correct the house wiring. If you still do not have dial tone, contact your service provider.



Troubleshooting USB Problems

Follow these steps if the computer does not auto-detect the Telephony Modem using a USB connection.

Before you start, make sure that:

- You have properly installed and configured the Telephony Modem as shown in [Installing and Connecting Your Telephony Modem](#).
- You have installed the USB drivers as shown in [Installing USB Drivers on Your PC](#).
- The cable company has set up your account. Call your cable company if you're not sure.

Instructions

- 1 Be sure that your computer is running either Windows 2000, Windows XP, or Windows Vista (Windows 95, Windows 98, and Windows NT are **not** supported).
- 2 Be sure the Telephony Modem has power. The **Power** light should be on.
- 3 Push the **Reset** button on the back panel of the Telephony Modem, using a pen tip or other sharp non-metallic object.
- 4 Disconnect the USB cable from the computer and reconnect it.
- 5 Restart the computer.
- 6 Do the following to uninstall and the reinstall your USB drivers:
 - a. Disconnect the USB cable to the Telephony Modem.
 - b. Insert the Telephony Modem CD-ROM into you computer.
 - c. Start the Remove utility on your CD-ROM. Follow the on-screen instructions carefully.
 - d. Reconnect the USB cable.
 - e. Re-install the USB driver as shown in [Installing USB Drivers on Your PC](#).
- 7 Replace the USB cable.
- 8 Call your cable company for help.



Glossary

The following is a list of common cable and networking terms.

A/B Cable

A USB cable that has a narrow rectangular connector on one end (A) and a notched square connector (B) on the other end.

Amp-hour (Ah)

A measure of battery capacity. For example, a 1.0Ah battery can nominally supply one Ampere of current for one hour.

Category 5 (Cat5)

A high-quality type of cable, used for Fast Ethernet (100BaseT) connections. When purchasing Ethernet cables, always look for Category 5 cable.

Coaxial cable (coax)

A thin wire, used to connect your television and Telephony Modem to the cable TV system. You can buy coax from any electronics retailer and many discount stores.

CPE

Customer Premise Equipment. This is the equipment that is plugged in to the telephony modem; typically a computer, hub, or router.

Cross-over

An Ethernet cable used to connect two hubs (or a hub and a cable modem) together. Also, some Ethernet hubs may have built-in cross-over on one or more ports (which eliminates the need for a cross-over cable).

DHCP

Dynamic Host Configuration Protocol. An IP protocol used to provide an IP address and location of services (such as DNS and TFTP) needed by a device connecting to the network. DHCP allows the cable company to configure your computer's networking software for you.

DNS

Domain Name Service (Server). An IP service that associates a domain name (such as www.example.com) with an IP address.



Downstream

In an HFC network, the direction from the head-end to the subscriber. Some older cable documentation may refer to this as the forward path.

DOCSIS

Data Over Cable System Interface Specification. The interoperability standards used for data communications equipment on an HFC network.

EMTA

Embedded Multimedia Terminal Adapter. An MTA device that is integrated with a cable modem.

Ethernet

A standard method of connecting two or more computers into a Local Area Network (LAN).

Euro-DOCSIS

The European version of DOCSIS.

Event

An informational message used for monitoring network status.

F-connector

The type of connector used on coax cable. There are two common types of F-connector, slip-on and screw-on. Use coax with screw-on connectors for connecting your Telephony Modem.

Gateway

The device, usually a router, that connects devices on a given IP subnet to other IP subnets.

Headend

The "central office" in an HFC network. The headend houses both video and data equipment. In larger cable networks, a "master" headend often feeds several "remote" headends to provide distributed services.

HTTP

HyperText Transfer Protocol.



Hub

A box with several Ethernet or USB connectors. Ethernet hubs provide a common point of contact for all connected devices; USB hubs allow you to add peripherals without installing a USB card in your computer.

IP address

A number assigned to your computer by your cable company, used to identify your computer to other systems on the Internet.

ISDN

Integrated Services Digital Network. A digital telephony standard that provides communication speeds about twice as fast as standard dialup.

LAN

Local Area Network. A network that allows computers in a single location (such as a building) to communicate with one another.

LED

Light Emitting Diode. A semi-conductor diode that emits light when current is passed through it.

MAC address

A number that uniquely identifies any device connected to a network. Your cable company uses your Telephony Modem's MAC address to authorize access to the Internet. The MAC address is printed on a label on the bottom of your Telephony Modem.

Protocol

A set of rules and formats that determines the communication behavior of network entities at a given layer.

Proxy

A device or program that stands in between a server (for example, a web site) and a client (your browser), providing a way to relieve some of the burden from the server. For example, your cable company may have a web proxy that keeps copies of popular web pages; the proxy can send you those pages instead of fetching them directly from the web site, resulting in faster page loading and less network congestion.



RF

Abbreviation for Radio Frequency. Some literature refers to coax as “RF cable” and the connectors as “RF connectors.”

RJ-11

A standard 4-pin modular connector, commonly used in North America for connecting telephones.

RJ-45

A standard 6-pin modular connector, commonly used on Ethernet cable. An RJ-45 connector looks like a wide RJ-11 (telephone) connector.

Splitter

A small box with three cable connectors: one input and two outputs. You may need a splitter if you have a TV already connected to the cable outlet that you want to use for your Telephony Modem. You can buy a splitter from any electronics retailer and most discount stores.

Switched outlet

A power outlet that may be turned on and off using a wall switch. Usually intended for lamps. Avoid plugging your computer or Telephony Modem into a switched outlet to avoid disruptions.

TCP/IP

Transmission Control Protocol/Internet Protocol. The protocols used to facilitate communications across one or more connected networks.

TDMA

Time Division Multiple Access. A method used by DOCSIS-compliant cable modems for sending upstream data with minimal interference.

Upstream

The path from a subscriber device to the headend. Some older cable documentation may refer to this as the return path or reverse path.

USB

(Universal Serial Bus) An interface used for connecting a variety of accessories, such as keyboards, mice, printers, and communications devices (such as cable modems) to a single computer.





Touchstone[®]
TM602 Telephony Modem
User's Guide

© 2005–2007 ARRIS Group, Inc.
All rights reserved

All information contained in this document is subject to change without notice. ARRIS reserves the right to make changes to equipment design or program components, as progress in engineering, manufacturing methods, or other circumstances may warrant.

ARRIS, Touchstone, and the ARRIS logo are trademarks or registered trademarks of ARRIS Group. All other trademarks and registered trademarks are the property of their respective holders.

Release 6 Standard 1.0
August 2007